



PLANNING COMMISSION MEETING
Stonecrest City Hall’s *Zoom Video - Suite 6:00 PM**
January 14, 2021
A G E N D A

As set forth in the Americans with Disabilities Act of 1990, the City of Stonecrest will assist citizens with special needs given notice (**7 working days**) to participate in any open meetings of the City of Stonecrest. Please contact the City Clerk’s Office via telephone (770.224-0200).

I. Call to Order

II. Roll Call

III. Approval of Minutes: ‘SPECIAL CALLED’ Planning Commission Meeting Minutes Summary dated November 10, 2020

IV. Old Business: None

V. New Business

1. Public Hearing(s):

**Meeting will be held virtually via the www.zoom.com. Meeting can be viewed on the City of Stonecrest YouTube page. Citizens wishing to make public comment can come to City Hall and make comments on a laptop running the Zoom application at the podium in Council Chambers or submit their questions via email address Lillian.Lowe@stonecrestga.gov.*

LAND USE PETITION: RZ-20-007
 PETITIONER: Phillip Loupe c/o Casswell Design Group LLC
 LOCATION: 5099 Browns Mill Road
 CURRENT ZONING: R-100 (Med Residential Lot) Zoning District
 PROPOSED DEVELOPMENT: Applicant is requesting to rezone 15.0 acres to MU-1 (Mixed-Use) Zoning District for a mixed-use development.

LAND USE PETITION: SLUP-20-007 & SLUP-20-008
 PETITIONER: Fairington Road Center LLC c/o Brady Hughes, Mahaffey Pickens Tucker, LLP
 LOCATION: 5961 Chupp Way
 CURRENT ZONING: M (Light Industrial) Zoning District
 PROPOSED DEVELOPMENT: Requesting Special Land Use Permit for the development of convenience store with accessory fuel pumps and alcohol outlet.

LAND USE PETITION: SLUP-21-001
 PETITIONER: Barnacles Restaurant c/o Bernice Monger
 LOCATION: 7300 Stonecrest Concourse
 CURRENT ZONING: C-2 (General Commercial) Zoning District
 PROPOSED DEVELOPMENT: Requesting Special Land Use Permit to operate as a late-night establishment

LAND USE PETITION: RZ-21-001 & SLUP-21-001
 PETITIONER: Alphabet Daycare
 LOCATION: 3174 Miller Road
 CURRENT ZONING: R-100 (Residential Med Lot) Zoning District
 PROPOSED DEVELOPMENT: Requesting to rezoned to RSM (Small Lot Residential Mix) and Special Land Use Permit to operate a Child Day Care Center

VI. Adjournment

LETTER OF INTENT

Bernice Monger
Barnacles Sport Lounge
7300 Stonecrest Concourse #100
Lithonia, GA 30058
Bmonger1@gmail.com

October 1, 2020

City of Stonecrest
Community Development Department
3120 Stonecrest Blvd.
Stonecrest, GA 30038

To Whom It May Concern:

I am submitting this letter with the intent to officially apply for the Special Land Use Permit, as was required by the zoning department, in order to receive an official signed permit and authorization, which will allow Barnacles Sport Lounge to remain open after midnight in zone C1, which is already approve for late night entertainment.

We are currently open after midnight as permitted in our current zoning, "Zone C1".

There will be no changes to our current operational activities or building structure. This authorization will give us the official documented needed to remain open as a late night entertainment as we continue to follow set criteria listed in our current Zone C1.

Respectfully,

Bernice Monger

LETTER OF INTENT

Bernice Monger
Barnacles Sport Lounge
7300 Stonecrest Concourse #100
Lithonia, GA 30058
Bmonger1@gmail.com

October 1, 2020

City of Stonecrest
Community Development Department
3120 Stonecrest Blvd.
Stonecrest, GA 30038

To Whom It May Concern:

I am submitting this letter with the intent to officially apply for the Special Land Use Permit, as was required by the zoning department, in order to receive an official signed permit and authorization, which will allow Barnacles Sport Lounge to remain open after midnight in zone C1, which is already approve for late night entertainment.

We are currently open after midnight as permitted in our current zoning, "Zone C1".

There will be no changes to our current operational activities or building structure. This authorization will give us the official documented needed to remain open as a late night entertainment as we continue to follow set criteria listed in our current Zone C1.

Respectfully,

Bernice Monger



Special Land Use Permit Application

Applicant Information	Name: <u>Bernice Monger</u>			
	Address: <u>1460 Appian Way</u>		<u>Lawrenceville, GA</u>	<u>30046</u>
	Phone: <u>678 237 2012</u>	Fax:	Email: <u>bmonger1@gmail.com</u>	
	Owner's Name: <u>Bernice Monger</u>			
	Owner's Address: <u>1460 Appian Way</u>			
	<u>Lawrenceville, GA 30046</u>			
	Phone: <u>678 237 2012</u>	Fax:	Email:	
	Property Address: <u>7300 Stonecrest Concourse Suite 100</u>		Acreage:	
	Parcel ID: <u>16 17001042</u>			
	Current Zoning Classification: <u>C1</u>			
Proposed Use of Property: <u>Restaurant/Spot Bar</u>				
Is this development and/or request seeking any incentives or tax abatement through the City of Stonecrest or any entity that can grant such waivers, incentives, and/or abatements? <input type="radio"/> Yes <input checked="" type="radio"/> No				

Property Information	Property Information: <u>7300 Stonecrest Concourse Suite 100 Lithonia, GA 30058</u>	
	<u>Barnacles Spot Lounge 5,000 sqft.</u>	

To the best of my knowledge, this variance application form is correct and complete. If additional materials are determined to be necessary, I understand that I am responsible for filing additional materials as specified by the City of Stonecrest Zoning Ordinance.

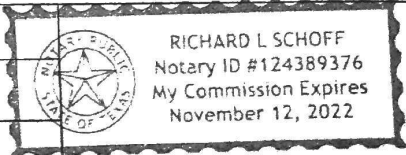
Affidavit	Applicant's Name: <u>Bernice Monger</u>			
	Applicant's Signature: <u>Bernice Monger</u>		Date: <u>9/28/2020</u>	
	Sworn to and subscribed before me this <u>26</u> Day of <u>September</u> 20 <u>20</u>			
	Notary Public: <u>Richard L. Schoff</u>			
	Signature: <u>Richard L. Schoff</u>			
My Commission Expires: <u>Nov 12, 2022</u>				
<input type="checkbox"/> Application Fee <input type="checkbox"/> Sign Fee <input type="checkbox"/> Legal Fee				
Fee: \$		Payment: <input type="checkbox"/> Cash <input type="checkbox"/> Check <input type="checkbox"/> CC		
<input type="checkbox"/> Approved <input type="checkbox"/> Approved with Conditions <input type="checkbox"/> Denied		Date:		



Campaign Disclosure Statement

Have you, within the two years immediately preceding the filing of this application, made campaign contributions aggregating \$250.00 or more to a member of the City of Stonecrest City Council or a member of the City of Stonecrest Planning Commission?

Yes No

Applicant / Owner	Signature: <i>[Handwritten Signature]</i>
	Address: 1460 Appian Way Lawrenceville, GA 30046
	Date: 9/10/2020

If you answered yes above, please complete the following section:

Date	Government Official	Official Position	Description	Amount



Applicant/Petitioner Notarized Certification

Petitioner states under oath that: (1) he/she is the executor or Attorney-In-Fact under a Power-of-Attorney for the owner (attach a copy of the Power-of-Attorney letter and type name above as "Owner"); (2) he/she has an option to purchase said property (attach a copy of the contract and type name of owner above as "Owner"); (3) he/she has an estate for years which permits the petitioner to apply (attach a copy of lease and type name of owner above as "Owner").

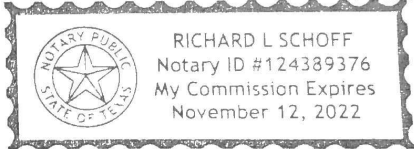
Applicant / Petitioner	Signature: <u>Bernice Dinger</u>		Date: <u>9/28/2020</u>	
	Address: <u>1460 Appian Way</u>		City, State: <u>Lawrenceville, GA</u> Zip: <u>30046</u>	
	Phone: <u>678 237 2012</u>			
	Sworn to and subscribed before me this <u>28</u> day of <u>Sept</u> , 20 <u>20</u>			
Attorney / Agent	Notary Public: <u>Richard L Schoff</u>			
	Signature:			Date:
	Address:		City, State:	Zip:
	Phone:			
	Sworn to and subscribed before me this _____ day of _____, 20____			
Notary Public:				

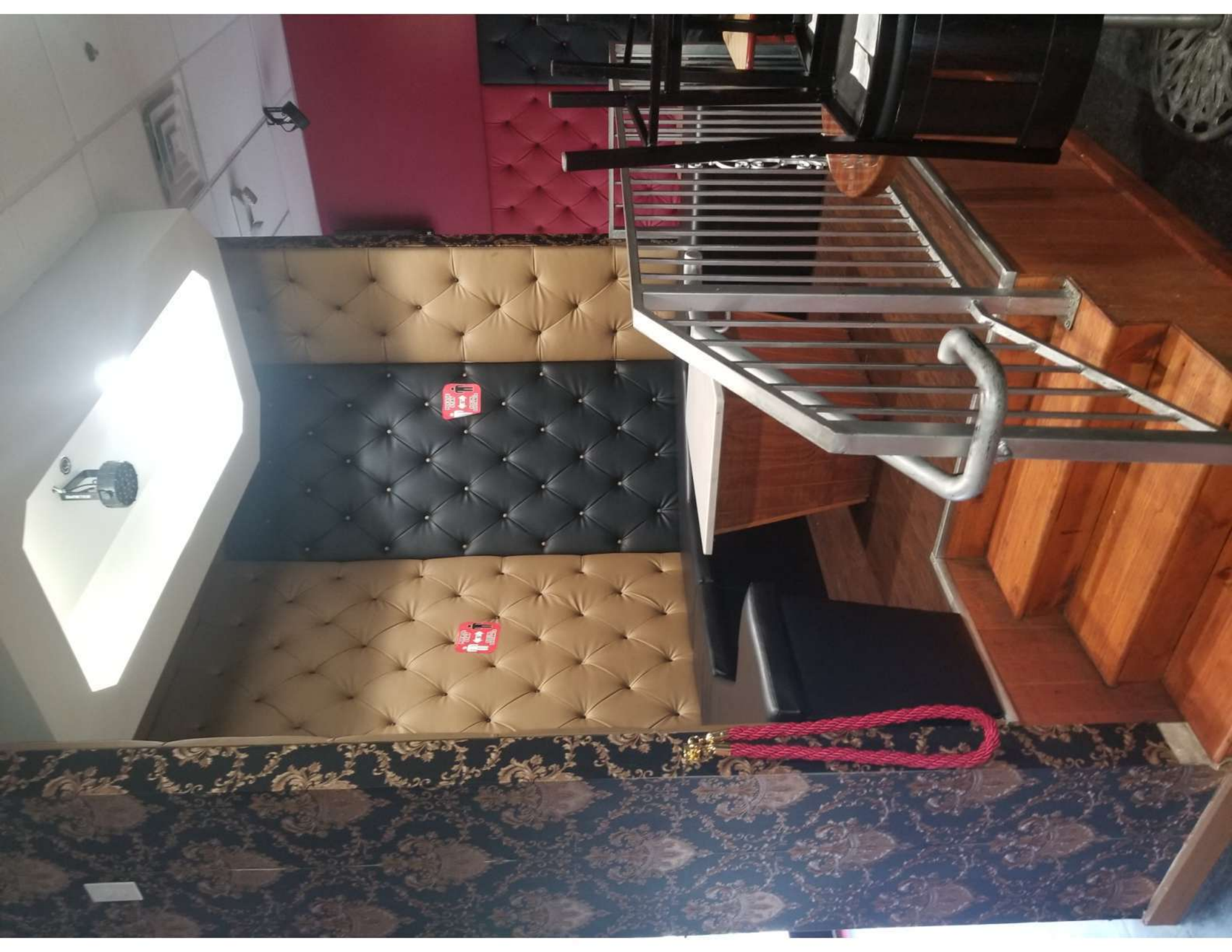

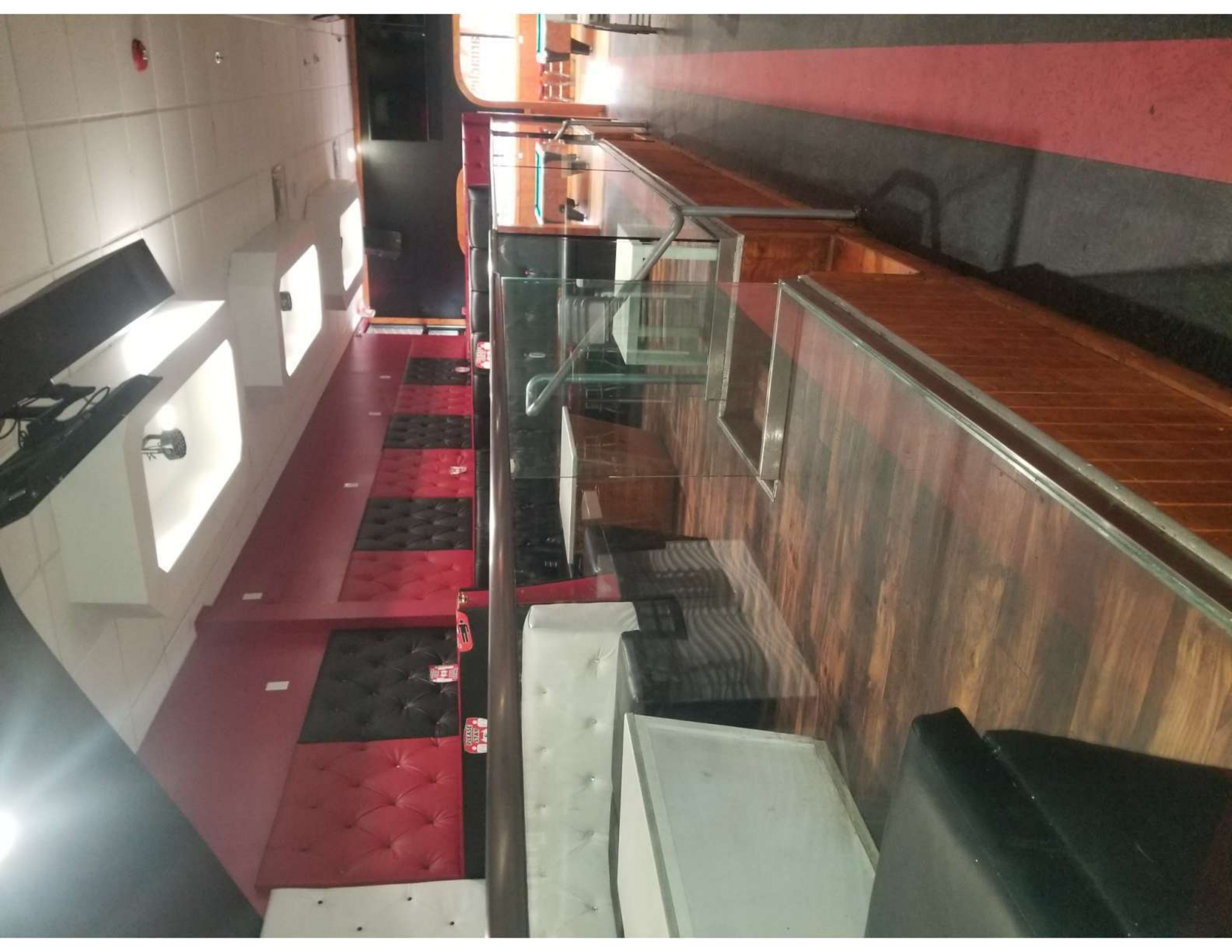



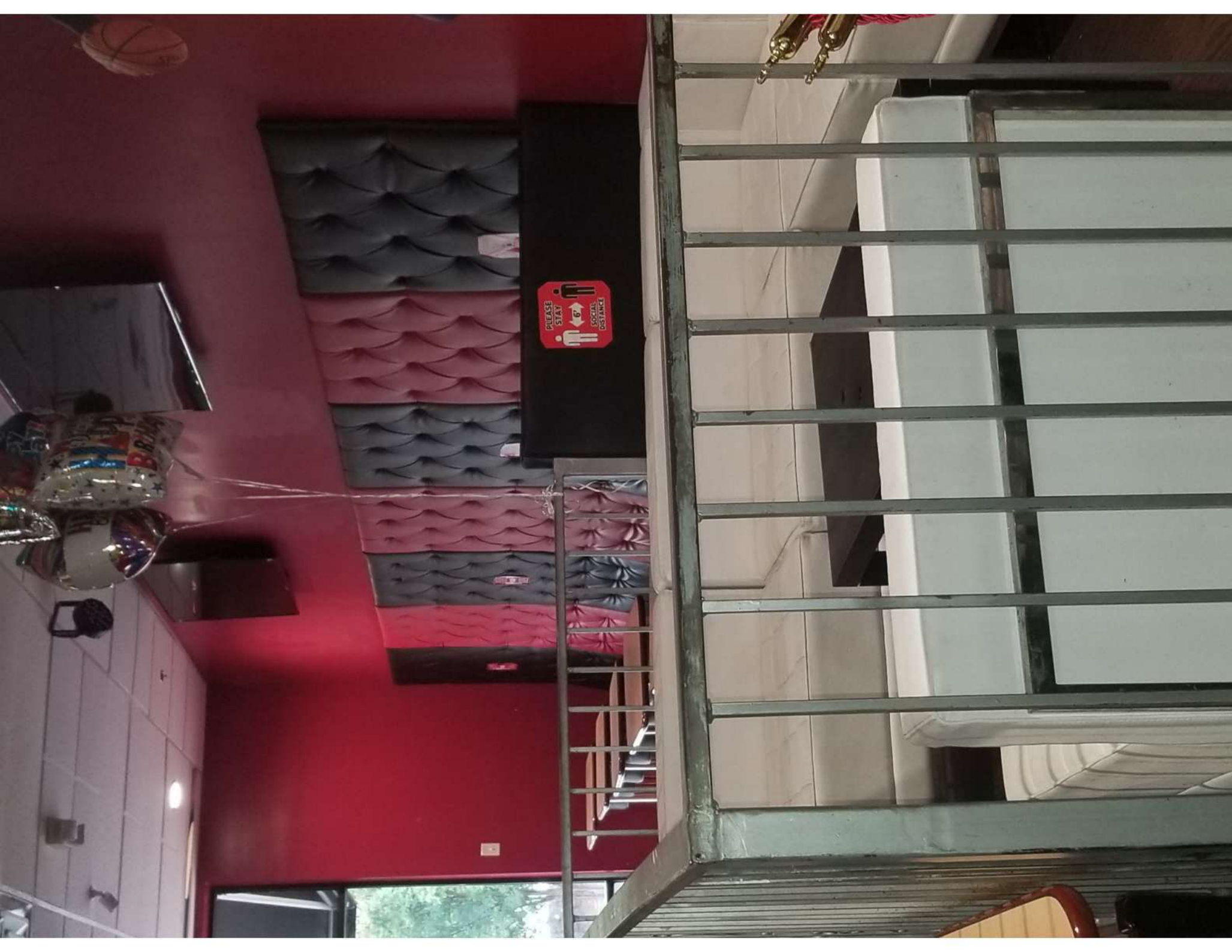

PLEASE STAY SOCIAL DISTANCE

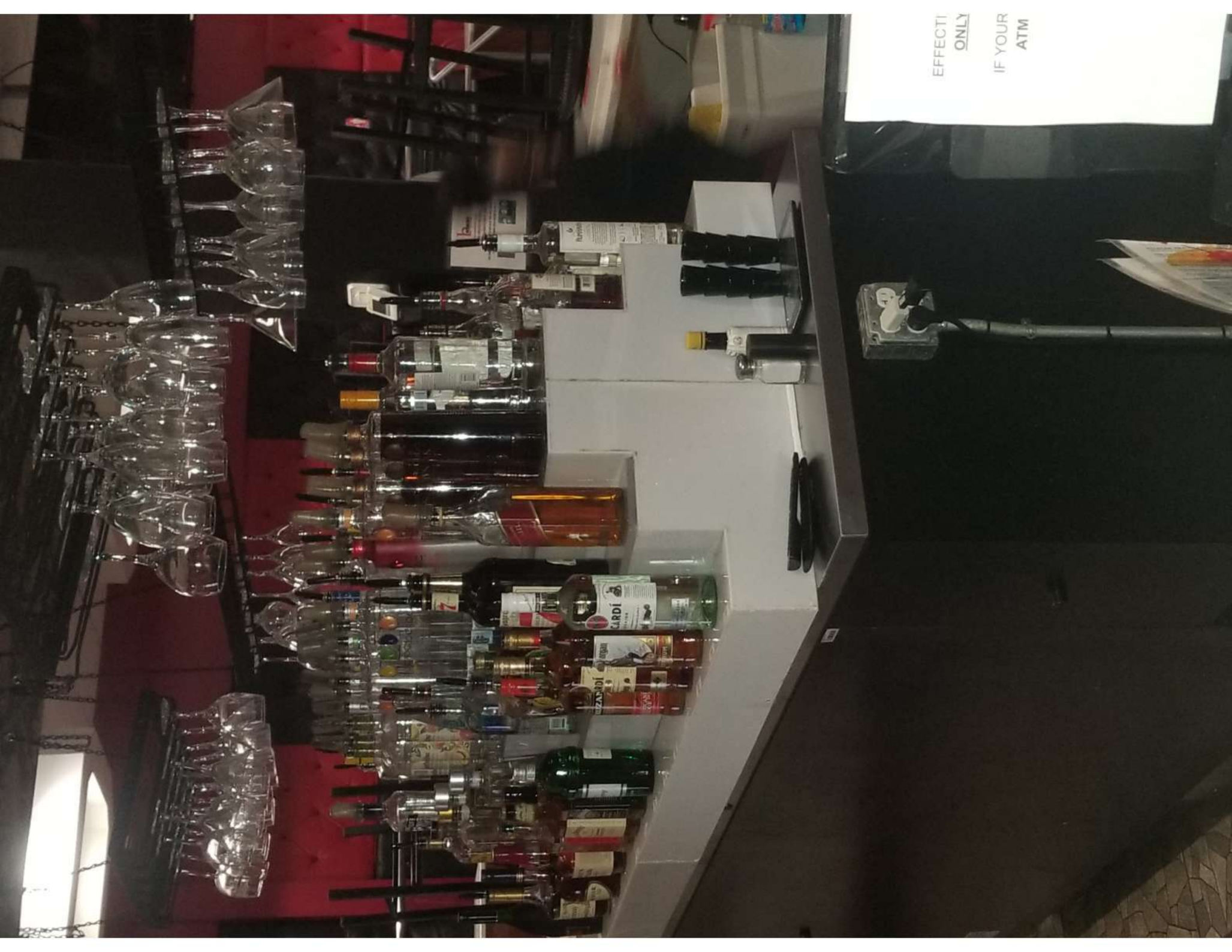

EFFECTI
ONLY
IF YOUR
ATM

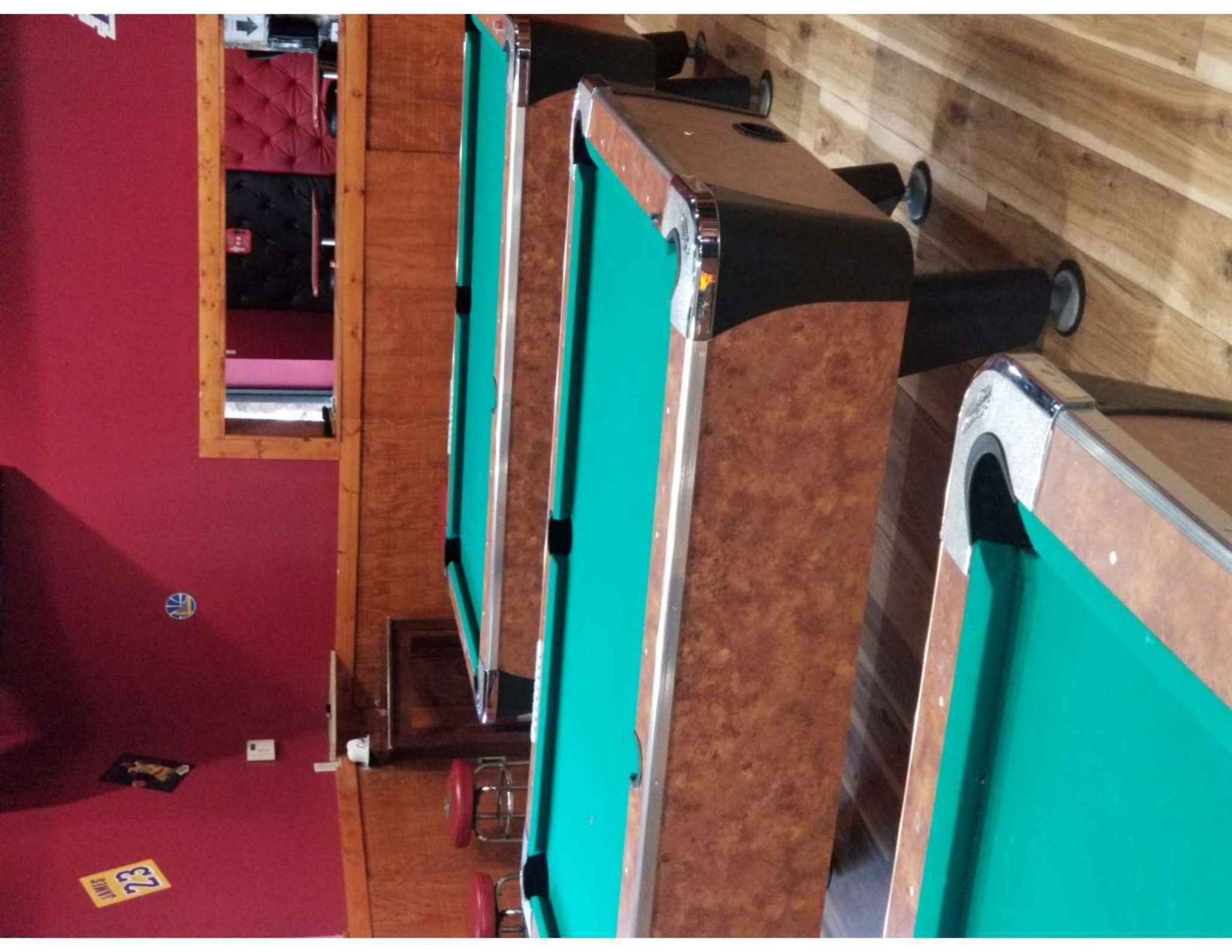

23



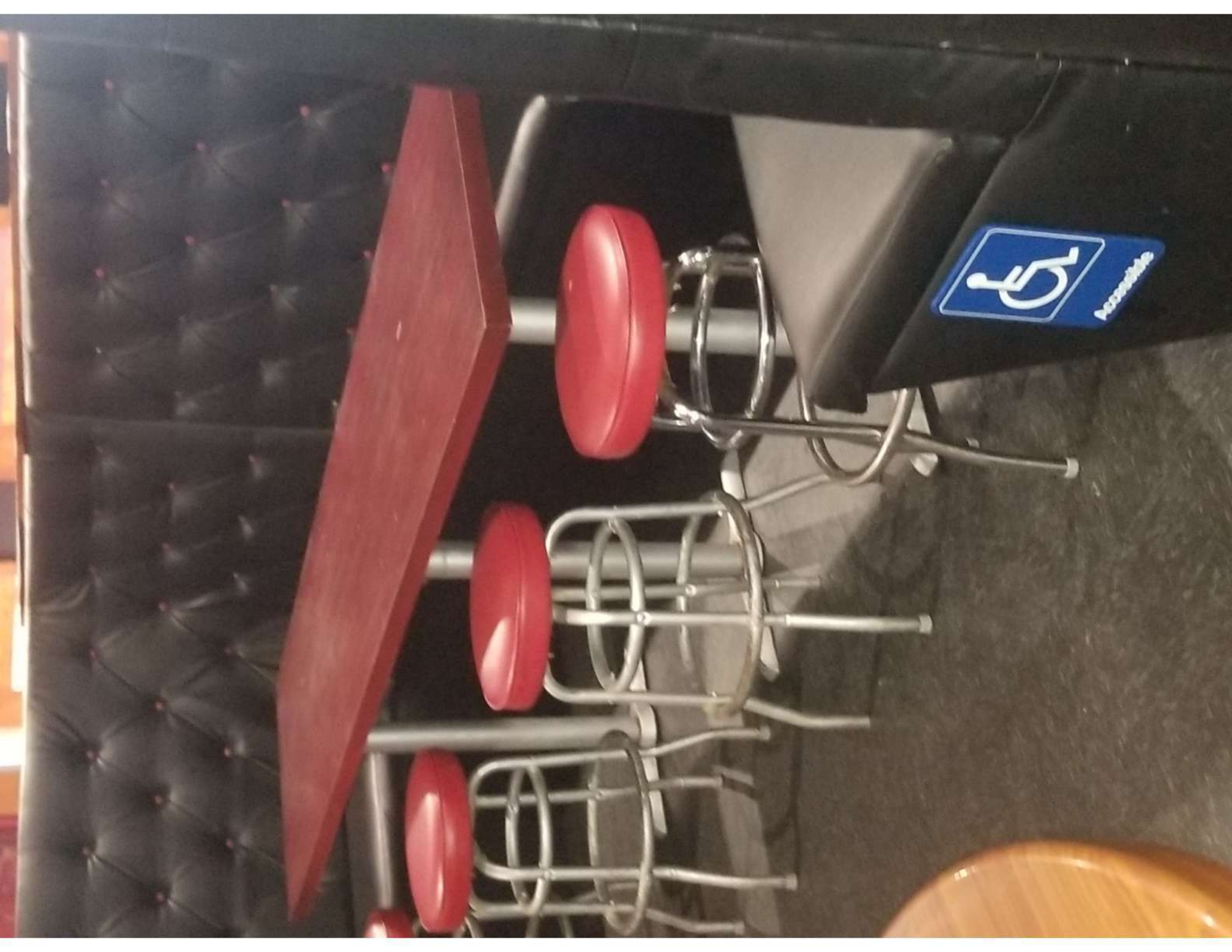

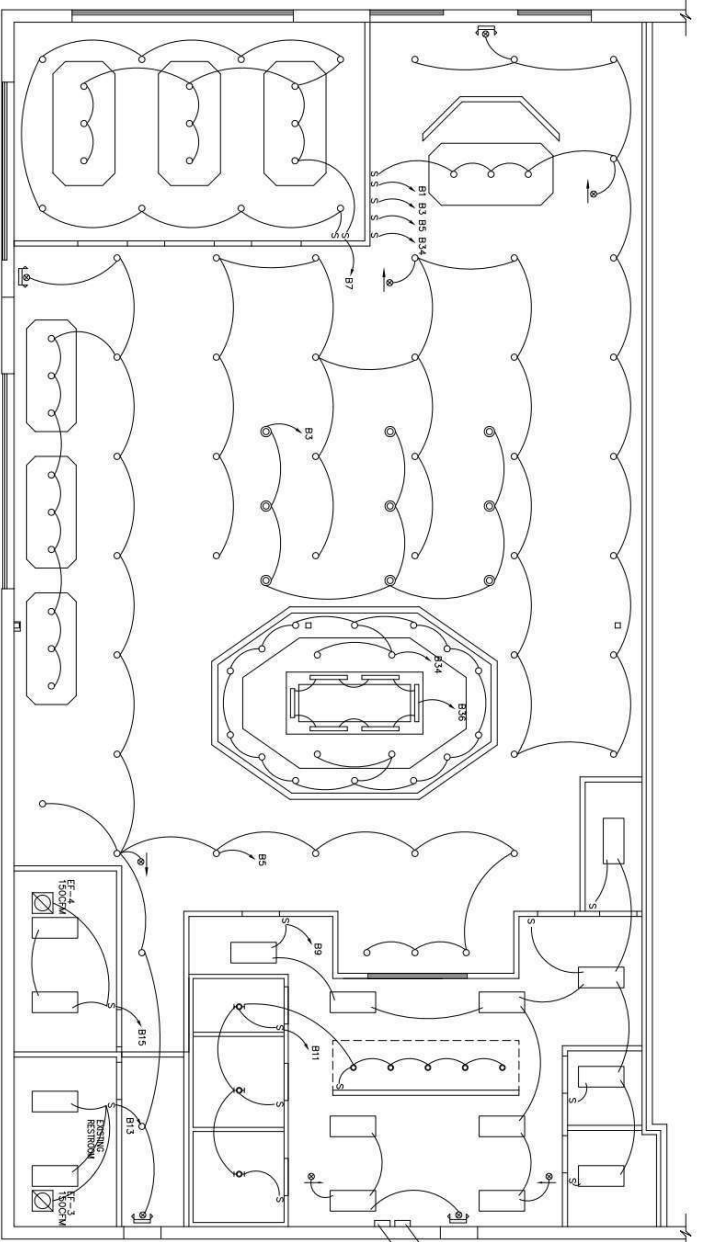

LIGHTING PLAN
3/16" = 1'-0"

PANELBOARD "B" SCHEDULE

CIRCUIT NO.	TO SERVE	LOAD (CIRCUIT BREAKER)		M.L.O.	CIRCUIT BREAKER TYPE	LOAD (KW)	CIRCUIT BREAKER NO.
		AMP	TRIP POINTS				
1	LIGHTS (DINING AREA)	0.7	20/1			1.0	STREPE SON
3	LIGHTS (DINING AREA)	1.0	20/1			1.0	RECEPT (POOL TABLE AREA)
5	LIGHTS (DINING AREA)	0.8	20/1			1.0	RECEPT (POOL TABLE AREA)
7	LIGHTS (POOL AREA)	0.5	20/1			1.0	RECEPT (DINING AREA)
9	LIGHTS (OUTDOOR AREA)	1.3	20/1			1.0	RECEPT (DINING AREA)
11	LIGHTS (MC/MC/MC/200)	0.5	20/1			1.0	RECEPT (BACK AREA)
13	FAN/LIGHTS (RESTROOM)	1.0	20/1			1.0	RECEPT (RESTROOM AREA)
15	FAN/LIGHTS (RESTROOM)	1.0	20/1			1.0	RECEPT (DINING AREA)
17	RECEPT (POS SYSTEM)	1.0	20/1			1.0	RECEPT (STAGE AREA)
19	REACH IN COOLER	1.0	20/1			1.0	RECEPT (STAGE AREA)
21	BEER COOLER	3.0	20/2			1.0	RECEPT (STAGE AREA)
23						1.0	RECEPT (O.I. AREA)
25	REACH IN COOLER	1.0	20/1			1.0	RECEPT (O.I. AREA)
27	RECEPT (MELT STATION AREA)	1.0	20/1			1.0	RECEPT (STAGE AREA)
29	SANITIZER UNIT	3.0	20/2			3.0	DISHWASHER
31							
33	REACH IN COOLER	1.0	20/1			1.0	LIGHTS (BAR AREA)
35	REACH IN FREEZER	1.0	20/1			1.0	TV
37	RECEPT (MELT STATION)	1.0	20/1				SPACE
39	RECEPT (POOL TABLE AREA)	1.0	20/1				SPACE
41	SPACE						SPACE

CONNECTED LOAD : 37.8 X 1000 / 1.732 / 208 = 100.0 A

ALL BRANCH BREAKERS NOT SPEC'D SHALL BE 20 AMP SINGLE POLE.
ALL BRANCH CIRCUITS CONDUCTORS NOT SPEC'D SHALL BE #12 WIRE WITH #12 GROUND

* MAIN BREAKERS

EXISTING PANELBOARD "A" SCHEDULE

CIRCUIT NO.	TO SERVE	LOAD (CIRCUIT BREAKER)		M.L.O.	CIRCUIT BREAKER TYPE	LOAD (KW)	CIRCUIT BREAKER NO.
		AMP	TRIP POINTS				
1	EXISTING RTU #1 510W	7.5	30/3			7.5	EXISTING RTU #2 510W
3							
5							
7	EXISTING RTU #3 510W	1.0	20/1			1.0	EXISTING
9	EXISTING RTU #3 510W	7.5	30/3			4.0	BEER WALK IN COOLER
11							
13						4.0	WALK IN COOLERS
15	EF-1	1.0	20/1				
17	EF-1	1.0	20/1			4.0	WALK IN FREEZER
19	EF-2	1.0	20/1				
21	MUA-1	1.0	20/1				SPACE
23	MUA-2	1.0	20/1				SPACE
25	ICE MAKER	1.5	20/1				SPACE
27	RECEPT (DINING AREA)	1.0	20/1				SPACE
29	RECEPT (DINING AREA)	1.0	20/1				SPACE
31	SPACE						SPACE
33	SPACE						SPACE
35	SPACE						SPACE
37	SPACE						SPACE
39	SPACE						SPACE
41	SPACE						SPACE

CONNECTED LOAD : 84.8 X 1000 / 1.732 / 208 = 226.0 A

ALL BRANCH BREAKERS NOT SPEC'D SHALL BE 20 AMP SINGLE POLE.
ALL BRANCH CIRCUITS CONDUCTORS NOT SPEC'D SHALL BE #12 WIRE WITH #12 GROUND

* MAIN BREAKERS

- ELECTRICAL POWER NOTES
1. Provide an ergonomic and flexible general arrangement of system and work locations. The system shall be designed to provide for future expansion and work in existing space and conditions. Maintain safety requirements that apply to the system. Verify locations and orientation of outlets and switches in related rooms with the architectural drawing and owner's representatives. Locations of equipment and conduits shall be verified with the owner's representatives prior to installation.
 2. Each panel board finished and installed under this contract shall be complete with a ground bus. This ground bus shall have a conductor grounding location for each ground bus. The ground bus shall be connected to the building's main ground bus. The conductor grounding location shall be noted on the drawings. The conductor grounding location shall be noted in accordance with Table 250-122 of the National Electrical Code (NEC).
 3. A full wire shall be installed between telephone outlets and the ground bus. The ground bus shall be connected to the building's main ground bus. The conductor grounding location shall be noted on the drawings. The conductor grounding location shall be noted in accordance with Table 250-122 of the National Electrical Code (NEC).
 4. All work performed by the contractor on this project shall be performed in a workmanlike manner and in accordance with all local and state codes, the NEC, OSHA and National Electrical Safety.
 5. All permits required for the construction of this work shall be obtained by the contractor. The contractor shall be responsible for the cost of all permits. The contractor shall provide for the cost of all permits. The contractor shall be responsible for the cost of all permits.
 6. All work performed by the contractor on this project shall be performed in a workmanlike manner and in accordance with all local and state codes, the NEC, OSHA and National Electrical Safety.
 7. All permits required for the construction of this work shall be obtained by the contractor. The contractor shall be responsible for the cost of all permits. The contractor shall provide for the cost of all permits. The contractor shall be responsible for the cost of all permits.
 8. Contractor shall provide "As Built" panel schedules complete with circuit designations and connected load data to the owner upon completion of work and on providing a copy on the inside of each panel.

BARNACLES SPORTS BAR & GRILL

7800 STONCREST CONCOURSE
SUITE # 100
LITHIUM, CA 95026

CUSTOM DESIGN
&
DEVELOPMENT
CORPORATION

1000 BURNING BAY
SUITE 200
MORNING, CA 90071
TEL: (714) 344-4444
FAX: (714) 344-4444

LIGHTING PLAN
NOTES & SCHEDULE

REVISION BY

DATE: 04/09/18

SCALE: AS NOTED

PROJECT NO:

E1

SHEETS

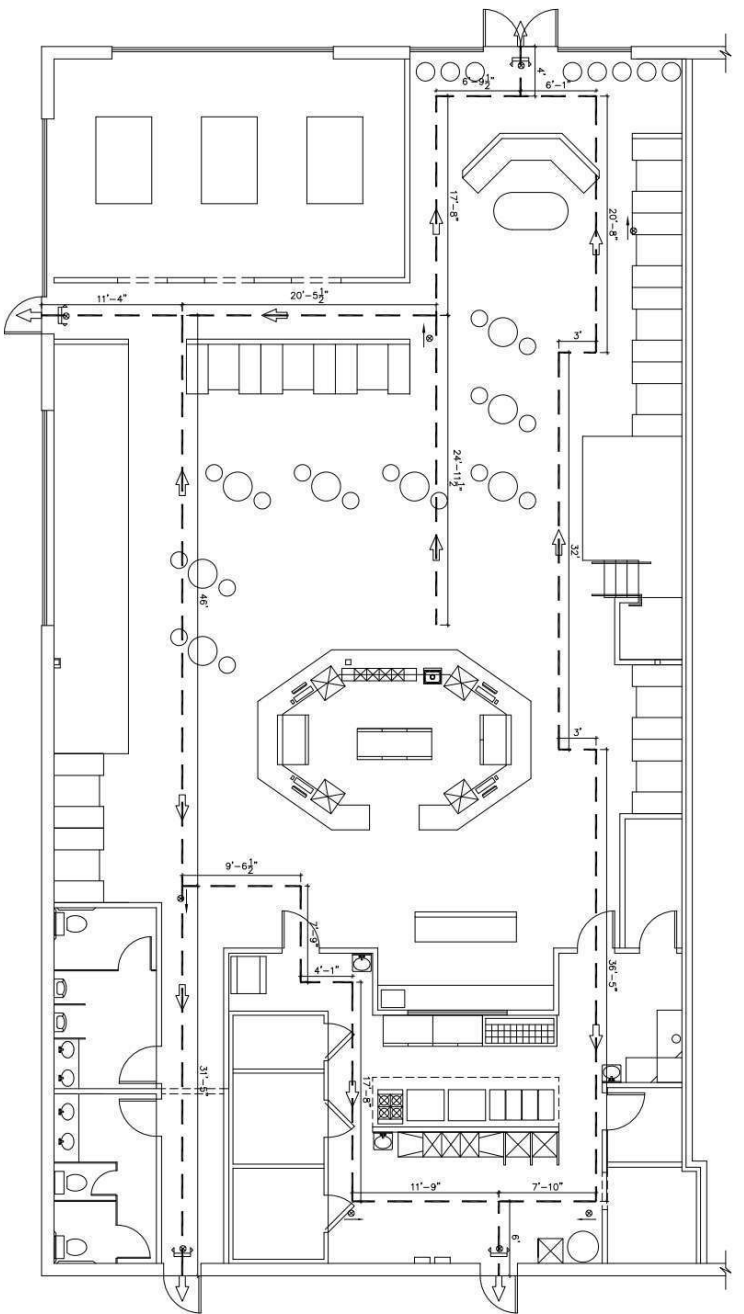

LIFE SAFETY PLAN
3/16" = 1'-0"

TOTAL SQ.FT. : 5,180 SQ.FT.
FE FIRE EXTINGUISHER

LIFE SAFETY NOTES

- NOTE: SECTIONS REFERENCED ARE FROM THE 2012 NFPA 101 LIFE SAFETY CODE WITH 2015 AMENDMENTS
- 12.2.1.5 - THE CLEAR WIDTH OF ANY CORRIDOR OR PASSAGEWAY SERVING AN OCCUPANT LOAD OF 50 OR MORE SHALL BE NOT LESS THAN 44 INCHES. CORRIDORS NOT LESS THAN 44 INCHES
 - 12.2.4.1 - AT LEAST ONE SEPARATE EXITS SHALL BE PROVIDED
 - 12.2.4.1 - 3 EXITS ARE PROVIDED
 - 12.2.5.1 - EXITS SHALL BE LOCATED REMOTELY FROM EACH OTHER AND SHALL BE ARRANGED TO MINIMIZE THE POSSIBILITY THAT THEY WOULD BE BLOCKED BY ANY OBSTRUCTION.
 - 12.2.6 - EXITS ARE LOCATED REMOTELY FROM EACH OTHER
 - 12.2.6 - TRAVEL DISTANCE TO EXITS, MEASURED IN ACCORDANCE W/ SECTION 7-6 SHALL NOT EXCEED 150 FEET
 - 12.2.6 - TRAVEL DISTANCE DOES NOT EXCEED 150 FEET
 - 12.2.8 - MEANS OF EGRESS SHALL BE ILLUMINATED IN ACCORDANCE WITH SECTION 7-8.
 - 12.2.8 - MEANS OF EGRESS ILLUMINATED
 - 12.2.8 - EMERGENCY LIGHTING SHALL BE PROVIDED IN ACCORDANCE WITH SECTION 7-9.
 - 12.2.10 - MEANS OF EGRESS SHALL HAVE SIGNS IN ACCORDANCE WITH SECTION 7-10.
 - 12.2.10 - MEANS OF EGRESS MARKED

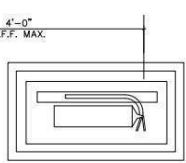

REFER TO 1/LS1.1
FOR FIRE
EXTINGUISHER
LOCATIONS

	<p>LIFE SAFETY PLAN NOTES & SCHEDULE</p>	<p>CUSTOM DESIGN & DEVELOPMENT CORPORATION</p> <p>3700 BARNACKLES BLVD. LITHONIA, GA 30058 TEL: (770) 244-8000 TEL: (770) 244-2000</p>		<p>BARNACKLES SPORTS BAR & GRILL</p> <p>7300 STONECREST CONCOURSE SUITE # 100 LITHONIA, GA 30058</p>												
<p>DRAWN BY: _____</p> <p>SCALE: AS NOTED</p> <p>PROJECT NO: _____</p> <p>DATE: 04/04/18</p> <p>SHEET _____</p>	<table border="1" style="width: 100%; border-collapse: collapse;"> <thead> <tr> <th>REVISION</th> <th>BY</th> </tr> </thead> <tbody> <tr><td> </td><td> </td></tr> <tr><td> </td><td> </td></tr> <tr><td> </td><td> </td></tr> <tr><td> </td><td> </td></tr> <tr><td> </td><td> </td></tr> </tbody> </table>	REVISION	BY											<p>OF _____ SHEETS</p>		
REVISION	BY															

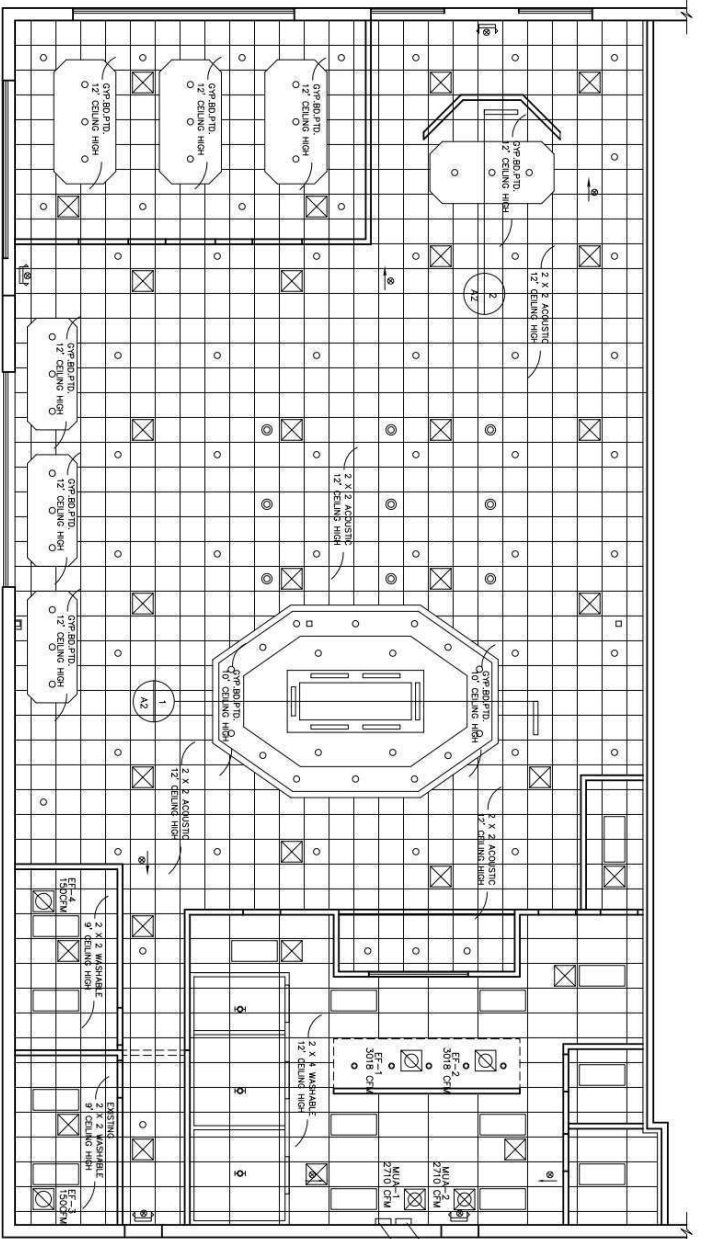

CEILING PLAN
3/8" = 1'-0"

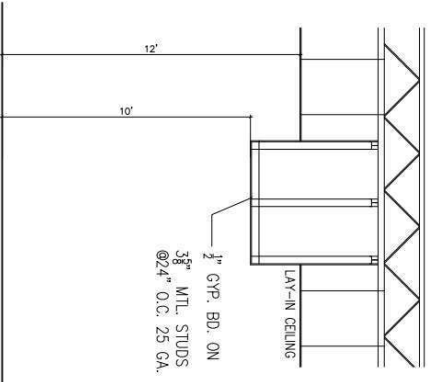

2 DETAIL
3/8" = 1'-0"

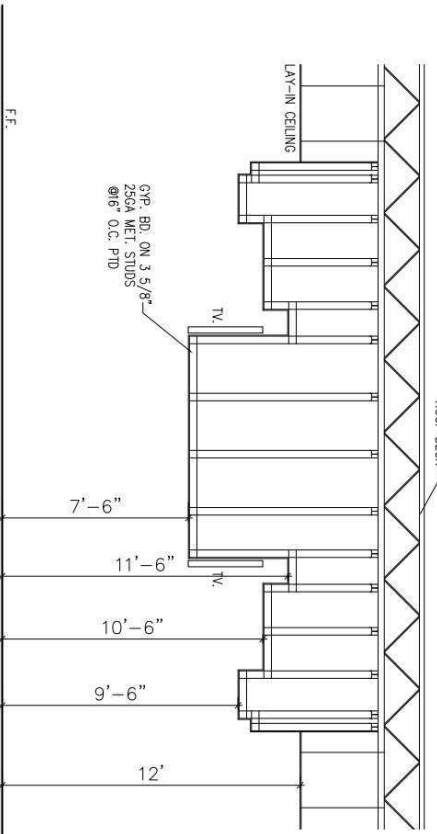

1 DETAIL
3/8" = 1'-0"

NOTE

1. CEILING LAY - IN 2X2 REGULAR SUSPENDED & CONTOURAL PANEL
2. CEILING LAY - IN 2X4 REGULAR SUSPENDED & CONTOURAL PANEL
3. CEILING LAY - IN 2X4 REGULAR SUSPENDED & CONTOURAL PANEL

SPACER BAR OR OTHER SUITABLE SYSTEM TO BE USED TO SUPPORT THE CEILING SYSTEM TO THE STRUCTURE ABOVE AND HANG FROM THE FENESTER.

* LIGHT TO MODERATE TREATMENT OF FENESTER WALL ATTACHED TO STRUCTURE ABOVE AND SUPPORT OF FENESTER CLOSURE IS LESS THAN MINIMUM 7/8 IN.

- 1) 12-GA HANGER WIRE FENESTER TO STRUCTURE ABOVE AND HANG FROM THE FENESTER.
- 2) 16-GA HANGER WIRE ASSIGNED TO FENESTER WALL ATTACHED TO STRUCTURE ABOVE AND SUPPORT OF FENESTER CLOSURE IS LESS THAN A 1/8 SLOPE (10').

SUSPENDED CEILING GRID SYSTEMS DETAIL
SCALE: NONE

	<p>BARNACLES SPORTS BAR & GRILL</p> <p>7300 STONECREST CONCOURSE SUITE 100 DUBLIN, GA 30144</p>		<p>CUSTOM DESIGN & DEVELOPMENT CORPORATION</p> <p>1000 W. BURNING WOOD DRIVE SUITE 300 MARIETTA, GA 30067 TEL: (770) 424-4444 FAX: (770) 424-4444</p>
<p>CEILING PLAN</p> <p>NOTES & SCHEDULE</p>			
<p>DATE: 04/04/18</p> <p>SHEET</p> <p style="font-size: 24pt; font-weight: bold;">A2</p> <p>OF SHEETS</p>	<p>SCALE: AS NOTED</p> <p>PROJECT NO:</p> <p>DESIGN BY:</p>	<p>REVISION</p> <p>BY</p>	<p>SCALE: NONE</p>

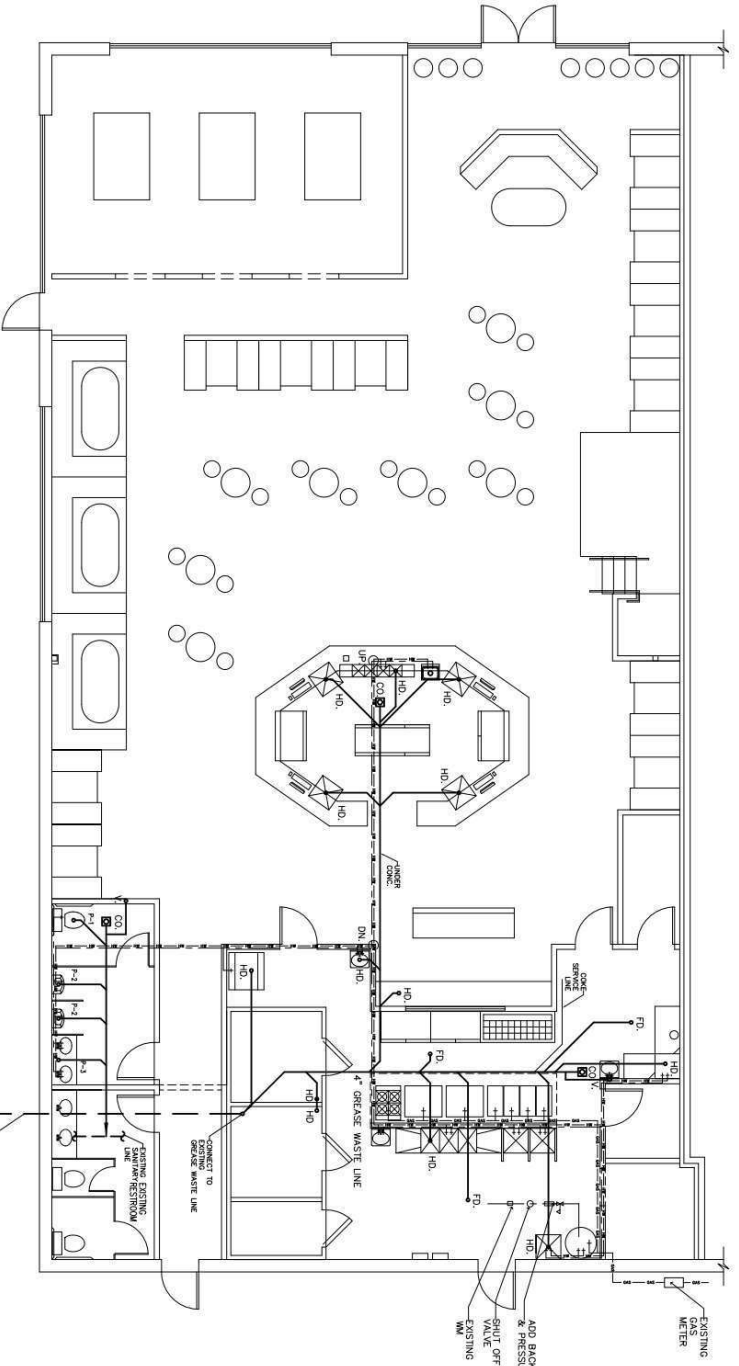

PLUMBING PLAN
3/16" = 1'-0"

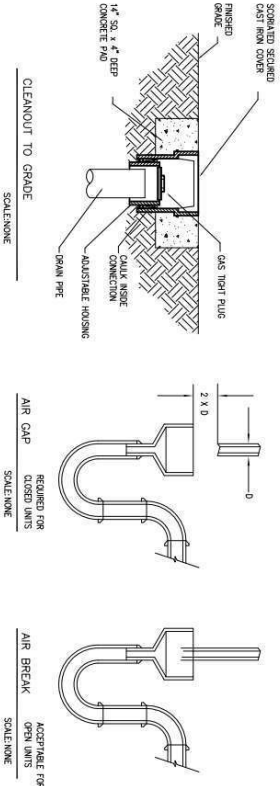

PLUMBING NOTES

- The drawing are diagrammatic only and show the intent of the design. The contractor shall provide all materials and labor to install a complete and operating system. The contractor shall apply for and pay for all required permits and inspections.
- Plumbing shall conform to the Georgia State plumbing code and all local codes and ordinances. All natural gas piping (NPG) and connections shall be installed in accordance with NPGA 54 and the special conditions specifications, if any.
- All sanitary, waste and vent pipe shall be DWV PVC or ABS piping and fittings. All hot and cold water piping and fitting above ground shall be CPVC. All natural gas pipe and fittings shall be schedule 40 black steel and fittings shall be screwed (NPT) and bonded.
- Alternate manufacturers of plumbing fixtures, floor drains, deposits and grease interceptors may be used if they are approved by the authority having jurisdiction. All plumbing fixtures shall be new and shall comply with ASH 117.1, 1980.
- All water heater shall be 100 g.p.h., 199,000 BTU/Hr.
- All water heater shall have T&P relief valve with discharge piped to 1'-0" above the ground outside.
- All piping shall be hung from pipe hangers as manufactured by the General Co., or equivalent, at 10'-0" o.c. maximum. Perforated metal straps and wire shall not be used.
- All vent for waste line to vent through roof (VTR) as noted.
- VACUUM BREAKER (WATER)
MOP/CAJ WASH
ICE MACHINE
VEGETABLE SINK
ICE MACHINE
MEAT SINK
ICE MACHINE
ICECREAM MACHINE

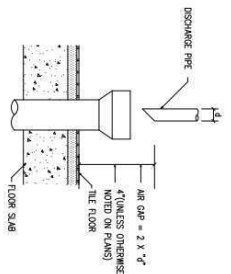

HUB DRAIN DETAIL
SCALE: NONE

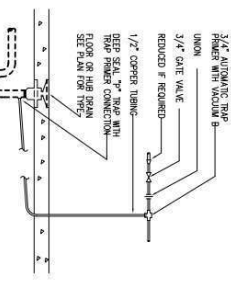

AUTOMATIC TRAP PRIMER
N.T.S.

DOMESTIC WATER HEATER SCHEDULE

UNIT	SERVICE	SOURCE	BTU	RECOVERY	CAPACITY	MANUFACTURER & MODEL NO.
MH1	DOMESTIC	GAS	199,000	194	100	AMERICAN STANDARD (0-100T-199-4S)

PLUMBING FIXTURE CONNECTION SCHEDULE

SYMBOL	DESCRIPTION	MINIMUM CONNECTION SIZE	WASTE	VENT	DIS	WV	WPC 1/2"	REMARKS
P-1	WATER CLOSET HANDICAPPED	4"	2"	1/2"	---	---	17"	FLOOR MOUNTED - FLUSH SINK
P-2	URINAL	2"	1-1/2"	3/4"	---	---	---	FLOOR MOUNTED - FLUSH SINK
P-3	LAVATORY	2"	1-1/2"	1/2"	1/2"	---	---	WALL MOUNTED
P-4	WIP SINK	3"	2"	1/2"	1/2"	---	---	FLOOR MOUNTED
P-5	3-COMPARTMENT SINK	3/4"	3/4"	3/4"	---	---	---	CONNECT WASTE
P-6	PIED SINK	1/2"	1/2"	1/2"	---	---	---	CONNECT WASTE

BARNACLES SPORTS BAR & GRILL
7300 STONECREST CONCOURSE SUITE # 100
LITHIA SPRING, FL 34886

CLIENT DESIGN & DEVELOPMENT CORPORATION
3750 UNIVERSITY BLVD., SUITE 300, MARIETTA, GA 30067
TEL: (770) 246-2666 FAX: (770) 246-2666

DATE: 04/26/18
SHEET: P1
OF SHEETS

PLUMBING PLAN
NOTES & SCHEDULE

REVISION	BY

DATE: 04/26/18
SHEET: P1
OF SHEETS



Property Owner(s) Notarized Certification

The owner and petitioner acknowledge that this Land Use Petition application form is correct and complete. By completing this form, all owners of the subject property certify authorization of the filing of the application and authorization of an applicant or agent to act on their behalf in the filing of the application including all subsequent application amendments.

Property Owner (If Applicable)	Signature: <u>Valerie Ketta</u>		Date: <u>10/05/20</u>
	Address: <u>8060 Preservation Dr</u>		City, State: <u>Alpharetta, GA</u> Zip: <u>30005</u>
	Phone: <u>585-414-0435</u>		
	Sworn to and subscribed before me this <u>5th</u> day of <u>October</u> , 20 <u>20</u>		
Property Owner (If Applicable)	Notary Public: <u>Elizabeth Flores Nunez</u> <u>Commission Exp. March 10, 2024</u> <u>Put to County.</u>		ELIZABETH FLORES NUNEZ Notary Public - State of Georgia Cherokee County My Commission Expires Mar 10, 2024
	Signature:		Date:
	Address:		City, State: Zip:
	Phone:		
Property Owner (If Applicable)	Sworn to and subscribed before me this _____ day of _____, 20 _____		
	Notary Public:		
	Signature:		Date:
	Address:		City, State: Zip:
Property Owner (If Applicable)	Phone:		
	Sworn to and subscribed before me this _____ day of _____, 20 _____		
	Notary Public:		

LEASE AGREEMENT

THIS LEASE AGREEMENT (the "Lease") is made and entered into this 4th day of December, 2019, between, Lithonia Property, LLC., a Georgia Limited Liability Corporation the "Landlord") and United Entertainment LLC., a Georgia Limited Liability Corporation (the "Tenant").

WITNESSETH:

FOR GOOD AND VALUABLE CONSIDERATION, the receipt, adequacy, and sufficiency, of which is hereby acknowledged, Landlord and Tenant, intending to be legally bound, hereby agree as follows:

ARTICLE I
DEFINITIONS AND FUNDAMENTAL PROVISIONS

1.1 Addresses for Bills & Notices:

LANDLORD: Lithonia Property, LLC
12 Mountain Road
Rochester, NY 14625
ATTN: Taib Elkettani
Tel: 585-414-0435
Email: casaproperty.te@gmail.com

TENANT: United Entertainment
LLC.
1460 Appian Way
Lawrenceville GA 30046
ATTN: Bernice P. Monger
Tel: 678-200-0503
Email: Barnaclesduluth@yahoo.com

1.2 Common Areas: Those areas, facilities, utilities, improvements, equipment, and installations, in the Shopping Center which are from time to time designated by Landlord for the nonexclusive use or benefit of Landlord and tenants of the Shopping Center, their employees, agents, customers, licensees and invitees. Common Areas include, but are not limited to, all parking lot areas, aisles, driveways, entrances, exits, walkways, sidewalks, roadways, loading area, service road, landscaped areas, exterior lighting, surface drainage facility, fences, roof gutters, and flat roof surface repair & maintenance.

1.3 Lease Term: Seven Years and Eight Months commencing on the date that the Tenant receives a fully executed lease from the Landlord and is granted full access to the Premises and expiring at 5:00 P.M. (EST) on the last day of the 84th Month of the Initial Term unless renewed as permitted herein. The first (1st) Lease Year shall consist of twelve (12) consecutive full calendar months plus the partial month, if any, caused by the Rental Commencement Date falling on other than the first day of a calendar month.

1.4 Minimum Rent: Initial Rate per Square Foot \$15.00 NNN- Annual escalation of Three (3%) percent per annum commencing on the 37th month after Commencement Date.

<u>Period</u>	<u>Square Footage</u>	<u>Annual Minimum Rent</u>	<u>Monthly Mini Rent</u>	<u>Rate/SF</u>
Months 1-8	5,000	\$0	\$0	\$0.00
Months 9-12	5,000	\$25,000.00	\$6,250.00	\$15.00
Months 13-24	5,000	\$75,000.00	\$6,250.00	\$15.00
Months 25-36	5,000	\$77,000.00	\$6,250.00	\$15.00
Months 37-48	5,000	\$77,250.00	\$6,437.50	\$15.45
Months 49-60	5,000	\$79,567.00	\$6,630.63	\$15.91
Months 61-72	5,000	\$81,954.53	\$6,829.54	\$16.39
Months 73-84	5,000	\$84,413.16	\$7,034.43	\$16.88

First Option Rent:

<u>Period</u>	<u>Square Footage</u>	<u>Annual Minimum Rent</u>	<u>Monthly Min Rent</u>	<u>Rate/SF</u>
Year 1	5000	\$86,945.56	\$7,245.46	\$17.39
Year 2	5,000	\$89,553.92	\$7,462.83	\$17.91
Year 3	5,000	\$92,240.54	\$7,686.71	\$18.45
Year 4	5,000	\$95,007.75	\$7,917.31	\$19.00
Year 5	5,000	\$97,857.99	\$8,154.83	\$19.57

Second Option Rent:

<u>Period</u>	<u>Square Footage</u>	<u>Annual Minimum Rent</u>	<u>Monthly Min Rent</u>	<u>Rate/ SF</u>
---------------	-----------------------	----------------------------	-------------------------	-----------------

Restaurant/Sports Bar & Grill/Live Entertainment with Dj Music

Without limiting the generality of the immediately-preceding sentence, Tenant shall not use the Premises for any use described on **Exhibit C** attached hereto. Notwithstanding anything contained in this Lease to the contrary, any breach of this provision which is not cured within five (5) days of written notice from Landlord shall constitute a Tenant default. Landlord's failure to notify or provide notice of such default does not constitute an acceptance of such default and Landlord has the right during the entire term of the Lease and any extension periods to notify the Tenant of any default.

- 1.8 Permitted Trade Name: d/b/a Barnacles Sports Bar & Grill
- 1.9 Premises: That certain space known as Suite 100 of the Shopping Center, consisting 5,000 square feet, as more particularly depicted on the Site Plan attached hereto as **Exhibit A** (which Site Plan is solely for the purposes of identifying the Premises, and shall not be deemed to be a covenant or representation by Landlord with respect to the configuration of the Shopping Center or any other aspect thereof).
- 1.10 Advance Rent Deposit: Seven Thousand Six Hundred and Forty-Five Dollars and 83/100 (\$7,645.83) to be applied as the first month's Minimum Rent and Operating Expenses first due and payable by Tenant hereunder upon execution of this Lease. The Advance Rent Deposit shall be paid to Landlord concurrently with the execution of this Lease.
- 1.11 Delivery of Possession: Upon full execution of the Lease.
- 1.12 Lease Commencement Date: Upon full execution of the Lease, Delivery and full Possession of the premises by Tenant.
- 1.13 Rental Commencement Date: Two hundred and Forty (240) days following full execution of this Lease Agreement. If the Premises are being leased in "AS IS" condition, then Tenant shall be deemed to have been given possession upon full execution of this Lease.
- 1.13 a. Rental Abatement Period: The Rental Abatement Period consists of a total of Two Hundred and Forty (240) days from the Lease Commencement Date. In the event that Tenant obtains his C.O.O. or opens for business within the Rental Abatement Period, the Tenant shall commence paying the Landlord his share of the C.T.I. expenses (CAM, Tax & Insurance). Rental payment shall start after the 240st day after the Lease Commencement Date.
- 1.14 Security Deposit: The security deposit shall be waived.
- 1.15 Tenant Allowance: An amount not to exceed Eighty-Seven Thousand Five Hundred dollars and no/100's (\$87,500.00) (equating to \$17.50 PSF) to be paid by Landlord to Tenant up on Tenant completing all the premises' improvements and presenting the Landlord with an unconditional Certificate of occupancy and lien waivers from all contractors. Tenant shall provide Landlord with permittable construction documents drawn by registered Architects and/or Engineers depicting the proposed Tenant Improvements for Landlord's approval. Tenant shall obtain the necessary building permits and comply with all applicable municipal codes, at his own cost. Tenant shall then select the various contractors, suppliers and vendors to successfully complete the renovations and open for business.
- 1.16 Shopping Center: That certain shopping center named as Stonecrest Festival and located at 7300 Stonecrest Concourse, Lithonia, GA 30038, DeKalb County, Georgia and more particularly described on **Exhibit A-1** attached hereto, as same may be altered, expanded, or reduced, from time to time at the discretion of Landlord.

ARTICLE II DEMISE OF PREMISES

2.1 Lease: Landlord hereby leases and demises to Tenant the Premises together with the nonexclusive right to use the Common Areas subject to the terms of this Lease, and further subject specifically to the Rules and Regulations of the Shopping Center, attached hereto as **Exhibit F**. Landlord reserves the right to amend the Rules and Regulations from time to time in its reasonable discretion.

2.2 Acceptance of Premises by Tenant: Notwithstanding **Exhibit B** ("Landlord's Work"), Tenant agrees to accept the Premises in an "AS-IS, WHERE-IS" condition as tendered by Landlord, WITH TENANT AGREEING THAT SUCH CONDITION IS SUITED FOR THE PERMITTED USE. TENANT HAS CONDUCTED ITS OWN INDEPENDENT EXAMINATION OF THE PREMISES, AND HAS NOT RELIED UPON AND WILL NOT RELY UPON, EITHER DIRECTLY OR INDIRECTLY, ANY REPRESENTATION OR WARRANTY OF LANDLORD OR ANY OF LANDLORD'S AGENTS OR REPRESENTATIVES, AND TENANT HEREBY ACKNOWLEDGES THAT NO SUCH REPRESENTATIONS HAVE BEEN MADE. LANDLORD SPECIFICALLY DISCLAIMS, AND NEITHER LANDLORD NOR ANY OTHER PERSON IS MAKING, ANY REPRESENTATION, WARRANTY OR ASSURANCE WHATSOEVER TO TENANT, AND NO WARRANTIES OR REPRESENTATIONS OF ANY KIND OR CHARACTER, EITHER EXPRESS OR IMPLIED, ARE MADE BY LANDLORD OR RELIED UPON BY TENANT WITH RESPECT TO THE MAINTENANCE, REPAIR, CONDITION, OR DESIGN OF THE PREMISES, OR ANY PORTION THEREOF, INCLUDING BUT NOT LIMITED TO (A) ANY IMPLIED OR EXPRESS WARRANTY OF MERCHANTABILITY, (B) ANY IMPLIED OR EXPRESS WARRANTY OF FITNESS FOR A PARTICULAR PURPOSE, (C) ANY IMPLIED OR EXPRESS WARRANTY OF CONFORMITY TO MODELS OR SAMPLES OF MATERIALS, (D) ANY CLAIM BY TENANT FOR DAMAGES BECAUSE OF DEFECTS, WHETHER KNOWN OR UNKNOWN, WITH RESPECT TO ANY IMPROVEMENTS OR PERSONAL PROPERTY LOCATED ON THE LAND, AND (E) THE COMPLIANCE OR LACK THEREOF OF THE PREMISES WITH

are available for Tenant's work or the date of Lease execution in the event the Premises is accepted in its "AS-IS, WHERE-IS" condition.

2.4 Surrender of Premises: At the expiration, or earlier termination, of the Lease Term, Tenant shall surrender the Premises to Landlord in a good and broom-clean condition, reasonable wear and tear excepted. Tenant shall promptly and at its sole expense repair any damage to the Premises caused by the removal of any furniture, trade fixtures, or other personal property, permitted or required by Landlord to be removed by Tenant from the Premises.

2.5 Renewal Option: Provided Tenant has never been in default under this Lease, Tenant shall have the option to extend the term of this Lease for Two (2) Option Periods of five (5) years each under the same terms and conditions as provided in the original Lease Term except for (a) Minimum Rent, which shall increase as set forth in Section 1.4 herein, and (b) no free rent or any other inducements from Landlord shall be provided with respect to any extension of the Term. To exercise said renewal option, Tenant shall give Landlord written notice of its election to renew the Lease Term not less than one hundred eighty (180) days prior to the expiration of the then-current Lease Term.

ARTICLE III RENT AND OTHER CHARGES

3.1 Minimum Rent: Tenant hereby covenants to pay Minimum Rent, in advance, on a monthly basis on the first day of each calendar month during the Lease Term, without demand, deduction, or setoff whatsoever; it being specifically agreed and understood that the covenants of Tenant to pay Minimum Rent, Additional Rent, and all other Rent set forth in this Lease, are separate and distinct covenants of Tenant, not contingent upon the performance of any other terms or conditions of this Lease. Minimum Rent for any partial calendar month during the Lease Term shall be prorated on a per diem basis.

3.2 Utilities: Tenant shall promptly pay all charges for utilities and other services furnished to the Premises whether by Landlord or the applicable utility company. Landlord shall not be liable for any interruptions or curtailment in utility services whether for alteration, repair, or improvement, of the Premises or the Shopping Center. Tenant shall be solely responsible for any impact fees, tap fees, connection fees or any other fees imposed by any utility company or any governmental authority with respect to the Premises or Tenant's use thereof. In the event any of the Shopping Center's tenants protest the way the water/sewer usage and/or the sanitation charges are applied, due to the nature of the Tenant business, Landlord shall have the right to install a separate dedicated sub-water meter and/or provide the Tenant with a separate dedicated dumpster. In such event, Tenant agrees to pay for the metered water usage and/or the dedicated dumpster through his monthly estimated CAM expenses contribution.

3.3 Operating Expenses: Tenant shall pay to Landlord along with its monthly installment of Minimum Rent, as "Additional Rent", Tenant's monthly share of all costs incurred by Landlord in maintaining the Common Area's, lighting, repairing, maintaining, replacing, operating, cleaning, painting, sweeping, securing, managing, and insuring the portions of the Shopping Center which are the responsibility of Landlord hereunder, including, without limitation, payment of all insurance premiums (including Worker's Compensation insurance and fidelity bonds for personnel of Landlord [it being agreed and understood that Landlord may self-insure or internally perform other functions relating to the Shopping Center included in Operating Expenses, and, in such event, Landlord may include in Operating Expenses the reasonable and competitive cost of such functions performed internally by Landlord]) and taxes and assessments associated with the Shopping Center including Ring Mall charges (collectively, the "Operating Expenses"). Tenant's annual share of Operating Expenses shall be computed by multiplying Operating Expenses by a fraction, the numerator of which shall be the number of square feet of the Premises and the denominator of which shall be the number of square feet of gross leasable area of the Shopping Center with the exception of the water/sewer and sanitation charges which for all practical purposes the Tenant agrees to pay as part of his annual CAM charges any amount above \$1164 per year with respect to the water/sewer services and any amount above \$1584 per year with respect to the sanitation charges. Adjustments to estimates of Tenant's share of Operating Expenses shall be made on an annual basis, and adjustments shall be made as to underpayment or overpayment of Operating Expenses by Tenant upon the annual determination of the actual Operating Expenses for the Shopping Center.

3.4 Security Deposit: Intentionally Deleted

3.5 Rent. As used herein, the term "Rent" shall include Minimum Rent, Additional Rent, Tenant's share of Operating Expenses and all other additional charges or sums payable to Landlord hereunder. All Rent shall be paid without demand, deduction or setoff whatsoever.

3.6 Rent Credit: Landlord and tenant agree that rent is based on the leasable 5000 SF as reflected in paragraph 1.4 of this lease. In the event that said premises is re-measured and the new measurement is not equal to 5000 SF, rent shall be adjusted accordingly. It is further agreed that any rent adjustment shall be done during the lease term on a yearly basis at the time the yearly CAM, Tax and Insurance reconciliation are done. Should the re-measured leased space be 4970 SF as indicated on the existing floor plans, Landlord agrees to credit tenant \$600 per year at the time the CAM, Tax, and Insurance reconciliations are done.

ARTICLE IV PERMITTED USAGE

4.1 Use: Tenant shall use, occupy, and operate in the whole of the Premises solely for the Permitted Use and for no other purpose whatsoever. Tenant covenants to continuously operate in the whole of the Premises solely utilizing the Permitted Use and Trade Name during minimum business hours of 10:00 am to 8:00 pm, Monday through Friday, 10:00 a.m. to 6:00 p.m. on Saturday, and 12:00 p.m. to 6:00 p.m. on Sunday. Tenant shall not, without Landlord's prior written consent, use the Premises for any purpose which increases the insurance premium cost or invalidates any insurance policy carried on the Premises or the Shopping Center.

4.4 Environmental Compliance. Tenant hereby agrees that: (a) Tenant shall conduct all of its operations at the Premises in compliance with all Environmental Laws, which term shall mean federal, state or local law, regulation, ordinance or the like governing, addressing or relating to Hazardous Substances, as hereinafter defined; (b) Tenant will not permit any Hazardous Substances to be brought into or stored on the Premises, except for the temporary storage in reasonable quantities of materials that are used in the ordinary course of the Permitted Use, provided such materials are properly stored in a manner and location meeting all Environmental Laws and approved in advance in writing by Landlord, provided that Tenant shall have obtained any required permits and shall pay any fees and provide any testing required by any governmental agency in connection therewith, and provided such materials shall be removed and disposed of by Tenant in accordance with all Environmental Laws and any required cleanup procedures shall be diligently undertaken by Tenant pursuant to all Environmental Laws; (c) Tenant will advise Landlord promptly in writing of any claim raised by any private party or governmental agency or relating to any use, discharge, dumping, spill or storage of any Hazardous Substance in any way affecting the Premises or the surrounding area; (d) no portion of the Premises will be used as a landfill or a dump; (e) Tenant will not install any underground or above-ground storage tanks of any type; (f) Tenant will not allow any surface or subsurface conditions to exist or come into existence that constitute, or with the passage of time may constitute a public or private nuisance. Landlord or Landlord's representative shall have the right, but not the obligation, to enter the Premises for the purpose of inspection to ensure compliance with all Applicable Laws, including all Environmental Laws. To the extent that Hazardous Substances are found to exist during any inspection or sampling event, Tenant shall be responsible for the expense of the inspection and sampling, as well as the expense of remediating the Hazardous Substances. Tenant shall indemnify, defend, and hold harmless Landlord from and against all claims, actions, damages, liability, and expense, of any nature whatsoever, foreseen or unforeseen as may result from Tenant's action or non-action with regard to its obligations under this Section or from Tenant's use of dry-cleaning solvents and dry-cleaning equipment at the Premises, including, without limitation, any claims for personal injury, property damage, or environmental damage that may result from Tenant's operation of a dry-cleaning business at the Premises. The costs for which Landlord is indemnified under this provision shall include, without limitation, legal fees, environmental consulting and engineering fees, and other professional or expert fees, which Landlord shall incur. The provisions of this Section 4.4 shall survive the expiration or early termination of this Lease.

As used herein, the term "Hazardous Substances" shall be interpreted broadly to include, but not be limited to, any material or substance that is defined, regulated or classified under federal, state, or local laws, including without limitation, as: (i) a "hazardous substance" pursuant to section 101 of the Comprehensive Environmental Response, Compensation and Liability Act, 42 U.S.C. §9601(14), section 311 of the Federal Water Pollution Control Act, 33 U.S.C. §1321, as now or hereafter amended; (ii) a "hazardous waste" pursuant to section 1004 or section 3001 of the Resource Conservation and Recovery Act, 42 U.S.C. §§6903, 6921, as now or hereafter amended; (iii) a toxic pollutant under section 307(a)(1) of the Federal Water Pollution Control Act, 33 U.S.C. §1317(a)(1); (iv) a "hazardous air pollutant" under section 112 of the Clean Air Act, 42 U.S.C. §7412, as now or hereafter amended; (v) a "hazardous material" under the Hazardous Materials Transportation Uniform Safety Act of 1990, 49 U.S.C. App. §1802(4), as now or hereafter amended; (vi) a toxic or hazardous material or substance pursuant to regulations promulgated now or hereafter under the aforementioned laws or any state or local counterpart to any of the aforementioned laws; (vii) a material or substance presenting a risk to human health or the environment under other applicable federal, state or local laws, ordinances, or regulations, as now or as may be passed or promulgated in the future; or (viii) any substance that after release into the environment and upon exposure, ingestion, inhalation, or assimilation, either directly from the environment or directly by ingestion through food chains, will or may reasonably be anticipated to cause death, disease, behavior abnormalities, cancer, or genetic abnormalities. "Hazardous Substances" specifically includes, but is not limited to, asbestos, polychlorinated biphenyls ("PCBs"), radioactive materials including naturally occurring radionuclides, petroleum and petroleum-based derivatives, and urea formaldehyde.

ARTICLE V ALTERATION, REPAIR, AND MAINTENANCE

5.1 Alterations by Tenant: Tenant shall not make any alterations (including, but not limited to, alterations to the exterior, the storefront, signs, or utility lines or systems within or serving the Premises), nor secure any fixtures, equipment, machinery, or other apparatus, to the Premises without Landlord's prior written approval, and Tenant shall promptly remove upon order from Landlord any decoration or alteration made or installed upon the Premises without Landlord's written consent. Landlord shall have the right to run utility lines, pipes, roof drainage pipes, conduit, wire, ductwork, or sprinkler systems, where necessary, through, in, or beneath, the Premises, and maintain same in a manner which does not unduly interfere with Tenant's use thereof.

5.2 Repairs by Tenant: Tenant shall keep by routine maintenance, repair, at its sole cost and expense, the interior of the Premises, together with the storefront and all door frames, doors, plate glass and windows of the Premises, and all electrical, plumbing, heating, ventilating, air conditioning and any other mechanical installations serving the Premises or located therein, whether or not in or under the floor slab or on the roof of the Premises, in good condition and working order at all times during the Term hereto. Tenant shall contract for any necessary pest control or exterminating services for the Premises. Tenant agrees to employ a suitable licensed contractor to perform Tenant's obligations for maintenance of the heating, cooling and ventilating including at least semiannual inspections and cleaning of the system together with such servicing as each such inspection shall disclose, and shall at all times keep in force an effect a maintenance contract with such contractors with respect to same; and further, Tenant shall keep in force, at Tenant's expense, at all time during the term a contract for the regular service and maintenance of the HVAC equipment serving the Premises. In the event Tenant fails to perform its maintenance, and repair obligations as provided herein, Landlord may, at its option, perform such remedial action on behalf of Tenant, and Tenant agrees to pay to Landlord, as Additional Rent, the cost thereof plus fifteen (15.0%) percent overhead promptly upon demand by Landlord. In the event that an HVAC unit(s) needs to be replaced, and provided that the Tenant has been maintaining the HVAC unit(s) as required per this lease, Landlord shall replace such unrepairable unit(s) at the request of the Tenant and Tenant shall contribute fifty percent (50%) of such replacement cost(s).

5.3 Liens: Tenant hereby indemnifies and holds Landlord harmless against, and shall keep the Premises and the Shopping

maintenance, repairs shall be the sole responsibility of Tenant with respect to Tenant's premises and shall be prorated with respect to the Common Areas. Landlord shall be responsible for the repair of the roof and all leakage before turning over the premises to Tenant.

5.6 Tenant's Work: All work required to prepare the Premises for the Permitted Use ("Tenant's Work") which is not specifically described as Landlord's Work in Exhibit "B" shall be the sole obligation of Tenant and shall be performed at the sole cost of Tenant in accordance with plans and specifications to be approved by Landlord. Tenant agrees to provide Landlord with permissible construction documents drawn by registered Architects and/or Engineers depicting Tenant's Work. Tenant shall also submit to Landlord a copy of the contractor's business license and a Certificate of Insurance from the contractor's insurer naming Landlord as an Additional Insured.

Tenant shall not be allowed to commence any Work until Landlord has approved in writing Tenant's proposed plans and specifications. Landlord and its representatives shall have the right to enter upon the Premises for the purpose of inspecting construction, the progress of the Tenant's Work, and compliance with the approved plans and specifications.

ARTICLE VI CASUALTY AND CONDEMNATION

6.1 Casualty. Landlord shall have the right, upon thirty (30) days prior written notice to Tenant, to terminate this Lease in the event (i) the Premises is damaged by fire or other casualty to the extent of more than ten (10.0%) percent of the replacement cost thereof, (ii) the Shopping Center is damaged by fire or other casualty to the extent of ten (10.0%) percent or more of the replacement cost thereof, (iii) any damage to the Premises cannot, in Landlord's sole discretion, be repaired within ninety (90) days of the date of such damage, or (iv) the Premises is damaged or destroyed during the last thirty (30%) percent of the Lease Term, or during any renewal or extension term of this Lease. If Landlord should elect to repair or rebuild the Premises because of any damage or destruction, Tenant shall at its sole expense replace all work and improvements originally installed or performed by Tenant, with such Tenant's work to be completed within ninety (90) days from Landlord's completion of Landlord's repair work (if any) subsequent to such casualty.

6.2 Condemnation. If the whole of the Premises, or so much thereof as to render the balance unusable by Tenant (as reasonably determined by Landlord), shall be taken under power of eminent domain, or otherwise transferred in lieu thereof, or if any part of the Shopping Center is taken and its continued operation is not in Landlord's sole opinion, economical, this Lease shall automatically terminate as of the date possession is taken by the condemning authority. No award for any total or partial taking shall be apportioned, and Tenant hereby unconditionally assigns to Landlord any award, which may be made in such taking or condemnation. In the event of a partial taking, which does not result in the termination of this Lease, Minimum Rent shall be apportioned according to the part of the Premises remaining usable by Tenant.

ARTICLE VII INSURANCE AND INDEMNIFICATION

7.1 Insurance. Tenant shall maintain at its sole expense, commencing upon the date Tenant open for business or 10 business days thereafter and continuing throughout the Lease Term, commercial general liability insurance covering the Premises in a combined single limit amount of not less than \$1,000,000.00 with a \$2,000,000.00 aggregate limit, naming Landlord and any mortgagee(s) of the Shopping Center as additional insureds thereunder. Tenant shall also keep in force, at its sole expense, plate glass, fire and extended coverage insurance for the full replacement value of Tenant's improvements and Tenant's property, including, but not limited to, 100% of inventory, 100% of trade fixtures, 100% of furnishings and other personal property, naming Landlord and any mortgagee(s) of the Shopping Center as additional insureds thereunder. The fire and extended coverage insurance maintained by Tenant shall be written so as to provide that the insurer waives all right of recovery by way of subrogation against Landlord in connection with any loss or damage covered by the policy (Tenant for itself, its successors and assigns, hereby waives any right of recovery against Landlord, its successors or assigns, by virtue of any casualty to the Premises or the Shopping Center). In addition, Tenant shall keep in force workman's compensation or similar insurance to the extent required by law. Should Tenant fail to effect the insurance called for herein, Landlord may, at its sole option, procure said insurance and pay the requisite premiums, in which event, Tenant shall pay all sums so expended plus fifteen (15.0%) percent as overhead to Landlord, as Additional Rent, immediately upon demand. Each insurer under the policies required hereunder shall agree by endorsement on the policy, or by independent instrument furnished to Landlord, that it will give Landlord at least thirty (30) days prior written notice before any policy or policies affecting the Premises shall be altered or cancelled. Each policy of insurance referred to herein shall name as the insured parties thereunder Landlord (including its agents and other parties designated by Landlord) and Tenant, as their interests may appear. The proceeds of such insurance shall not be used, except with the consent of Landlord, for any purpose other than the repair or replacement of property situated within the Premises, and for any third-party liability. Notwithstanding anything contained herein to the contrary, Tenant shall not be permitted to store, sell or give away any such fermented, alcoholic or other intoxicating liquor or beverage on the Premises unless (a) Landlord shall have specifically consented thereto in writing, (b) such use shall be within the Permitted Use, (c) Tenant shall have obtained all required licenses and permits in connection therewith, and such licenses and permits shall be in full force and effect, and (d) Tenant's insurance covers all claims arising under applicable laws relating to the storage, sale, use or giving away of any fermented, alcoholic or other intoxicating liquor or beverage, which claims could be asserted against Landlord, Tenant or the Premises, in amounts and form reasonably acceptable to Landlord. Tenant shall deliver a copy of said insurance to the Landlord upon obtaining the C.O.O and prior to opening for business. During the renovation period, Tenant's contractor shall carry liability insurance on the said premises and shall name the Landlord as additional insured.

ARTICLE VIII
DEFAULT AND REMEDIES

8.1 **Events of Default:** In the event Tenant (i) fails to pay all or any portion of any sum due from Tenant hereunder or pursuant to any Exhibit hereto as and when such payment is due; (ii) fails to cease all conduct prohibited hereby within two (2) business days upon receipt of written notice from Landlord; (iii) fails within two (2) business days to take actions in accordance with the provisions of written notice from Landlord to remedy Tenant's failure to perform any of the terms, covenants and conditions of this Lease; (iv) fails to conduct business in the Premises as herein required; (v) commits an act in violation of this Lease which Landlord has previously notified Tenant to cease more than once in any Lease Year; (vi) becomes bankrupt, insolvent or files any debtor proceeding, takes or has taken against Tenant any petition of bankruptcy; takes action or has action taken against Tenant for the appointment of a receiver for all or a portion of Tenant's assets, files a petition for a corporate reorganization; makes an assignment for the benefit of creditors, or if in any other manner Tenant's interest hereunder shall pass to another by operation of law (any or all of the occurrences in this subsection being deemed a default on account of bankruptcy for the purposes hereof and such default on account of bankruptcy shall apply to and include any guarantor of this Lease); (vii) commits waste to the Premises; or (viii) is otherwise in breach of Tenant's obligations hereunder and shall not have cured such other default within ten (10) days following written notice from Landlord; then Tenant shall be in default hereunder and Landlord may, at its option and without further notice to Tenant, terminate Tenant's right to possession of the Premises and without terminating this Lease re-enter and resume possession of the Premises and/or declare this Lease terminated, and may thereupon in either event remove all persons and property from the Premises, with or without resort to process of any court, either by force or otherwise. Notwithstanding such re-entry by Landlord, Tenant hereby indemnifies and holds Landlord harmless from any and all loss or damage, which Tenant may incur by reason of the termination of this Lease and/or Tenant's right to possession hereunder. In no event shall Landlord's termination of this Lease and/or Tenant's right to possession of the Premises abrogate Tenant's agreement to pay Rent for the full Lease Term. Following re-entry of the Premises by Landlord, Tenant shall continue to pay all Rent as it becomes due under the terms of this Lease, or at Landlord's option, all Rent for the balance of the Lease Term shall be deemed immediately due and payable by Tenant to Landlord, together with all other expenses incurred by Landlord in regaining possession, including full reimbursement of any and all free rents or abated rents as well as all unamortized, excluding any term associated with free or abated rent, leasing commissions and tenant improvement costs which were incurred by Landlord in connection with this Lease; it being understood that Landlord shall have no obligations to mitigate Tenant's damages by reletting the Premises. Should Landlord relet the Premises, Tenant shall also pay Landlord, as liquidated damages for the failure of Tenant to honor its obligations under this Lease, for each month of the period which would otherwise have constituted the balance of the Lease term, any deficiency between (i) the sum of the monthly installment of Minimum Rent and Additional Rent and other charges which would have been due under this Lease for such month and (ii) the net amount, if any, actually collected on account of the lease of the Premises for such month. In computing such liquidated damages, there shall be added to said deficiency such expenses as Landlord may incur in connection with any reletting, such as court costs, reasonable attorney's fees and disbursements, brokerage fees and expenses for preparing the Premises for reletting. Any such liquidated damages shall be paid in monthly installments by Tenant on the 1st day of each month, and any suit brought to collect the amount of deficiency for any month shall not prejudice the rights of Landlord to pursue similar proceedings regarding subsequent months.

If this Lease is terminated by Landlord as a result of the occurrence of an event of default, Landlord may declare to be due and payable immediately, the present value (calculated with a discount factor of eight percent [8%] per annum) of the difference between (i) the entire amount of Rent and other charges and assessments which in Landlord's reasonable determination would become due and payable during the remainder of the Lease Term determined as though this Lease had not been terminated, and (ii) the then fair market rental value of the Premises for the remainder of the Lease Term. Upon the acceleration of such amounts, Tenant agrees to pay the same at once, together with all Rent and other charges and assessments theretofore due, at Landlord's address as provided herein, it being agreed that such payment shall not constitute a penalty or forfeiture but shall constitute liquidated damages for Tenant's failure to comply with the terms and provisions of this Lease (Landlord and Tenant agreeing that Landlord's actual damages in such event are impossible to ascertain and that the amount set forth above is a reasonable estimate thereof).

8.2 **Rights and Remedies:** The various rights and remedies herein granted to Landlord shall be cumulative and in addition to any other rights or remedies which Landlord may be entitled to at law or in equity. The exercise of one or more rights or remedies of Landlord shall not impair Landlord's right to exercise any other right or remedy. In all events, Landlord shall have the right, upon notice to Tenant, to cure any breach by Tenant, at Tenant's sole cost and expense, and Tenant shall reimburse Landlord for such costs and expenses plus fifteen (15%) percent as overhead, immediately upon demand.

ARTICLE IX
ASSIGNMENT AND SUBLETTING

9.1 **Assignment and Subletting:** Tenant shall not, either voluntarily or by operation of law, sell, assign, hypothecate or otherwise transfer this Lease, or sublet the Premises or any part thereof (all of the foregoing collectively referred to as a "Transfer"), without the express prior written consent of Landlord. Tenant shall not be released from, and shall remain principally and primarily liable for, the full and prompt performance of each of the terms and provisions of this Lease following any Transfer. The acceptance by Landlord of Rent following any Transfer shall not be deemed to be a consent by Landlord to any such Transfer, nor shall such acceptance of Rent be deemed a waiver of any right or remedy of Landlord hereunder.

9.2 **Exclusivity:** During the Lease Term, and any extensions thereof, the Landlord shall not lease to any other tenant any unit in the shopping center to engage in any business engaging in a Sports bar or Night Club.

ARTICLE XI
MISCELLANEOUS

- 11.1 **Attorney's Fees:** If any Rent, Additional Rent, Additional Charges or other charges owing under this Lease are collected by or through an attorney at law, whether or not litigation is actually instigated, the Landlord shall be entitled to recover reasonable attorneys' fees in the amount of 15.00% of such sums due, as well as the other costs of such proceedings.
- 11.2 **Late Charges:** All Rent, Additional Rent, Additional Charges or other charges owing under this Lease and which are not paid 10 days after its due shall bear a fee of \$150.00 for processing of late payments. In the event that any check, bank draft or other instrument given to Landlord for any payment under this Lease shall be dishonored for any reason whatsoever not attributable to Landlord (ii) Tenant shall replace such check with a cashier's check within 48 hours of notice (oral or written) to Tenant by Landlord of the dishonor, and (iii) Landlord shall have the right to elect that the next six (6) subsequent monthly installments of Minimum Rent and Additional Rent be paid by cashier's checks.
- 11.3 **Accord and Satisfaction:** No payment by Tenant or receipt by Landlord of a lesser amount than the charges herein stipulated shall be deemed to be other than on account of the earliest stipulated charges, nor shall any endorsement or statement on any check or letter accompanying any check or payment be deemed an accord and satisfaction, and Landlord may accept such check or payment without prejudice to Landlord's right to recover the balance of any amounts due hereunder or to pursue any other remedy provided herein.
- 11.4 **Time of Essence:** TIME IS OF THE ESSENCE OF THIS LEASE.
- 11.5 **Holding Over:** If Tenant holds over at the end of the Lease Term without the written consent of Landlord, Tenant shall be deemed a tenant-at-sufferance and Tenant shall pay to Landlord, during each month of such holdover period, as liquidated damages, a sum equal to double the highest amount of Rent paid by Tenant to Landlord during any month of the Lease Term; provided, however, acceptance of Rent by Landlord shall not be interpreted as a grant of permission for Tenant to continue in possession of the Premises.
- 11.6 **Severability:** In the event any provision of this Lease to any extent shall be deemed invalid or unenforceable, the remainder of this Lease shall not be affected thereby, and the Lease and the remaining provisions thereof shall be valid and enforceable to the full extent permitted by law.
- 11.7 **Brokers:** Tenant indemnifies Landlord, and Landlord indemnifies Tenant, against any claims for brokerage commissions in connection herewith, except for the brokerage commission payable to Schair & Associates, Inc. (the "Broker"). Tenant hereby acknowledges that Schair & Associates, Inc. has served solely as agent for Landlord in connection with this Lease and its commission shall be paid by Landlord in accordance with a separate agreement. Landlord hereby acknowledges that N/A has served solely as agent for Tenant in connection with this Lease and its commissions shall be paid by Landlord in accordance with a separate agreement.
- 11.8 **Waiver:** No waiver by Landlord of any provision of this Lease shall be deemed to be a waiver of any other provision hereof or of any subsequent breach by Tenant of the same provision. Landlord's consent to, or approval of, any act by Tenant shall not be deemed to render unnecessary the obtaining of Landlord's consent to, or approval of, any subsequent act. No agreement by Landlord to accept Tenant's surrender of the Premises shall be valid unless in writing from Landlord.
- 11.9 **Right of Entry:** Landlord shall have free access to the Premises at all reasonable times to inspect the Premises and to make such repairs, additions, improvements, changes, or alterations, the Shopping Center, as Landlord may elect. Landlord may also place "For Lease" or "For Sale" signs on the Premises forty-five (45) days before the termination of this Lease. Landlord or its agents or designees, during the Term of this Lease, or any renewal thereof, may enter the Premises at reasonable hours to exhibit same to prospective purchasers or Tenants, or for any other reasonable purpose.
- 11.10 **Successors and Assigns:** Except as otherwise provided herein, this Lease shall be binding upon and inure to the benefit of the parties hereto and their respective heirs, personal representatives, executors, successors and assigns.
- 11.11 **Headings, Captions and References:** The Article and Section captions contained in this Lease are for convenience only and do not in any way limit or amplify any terms or provisions hereof. The use of the terms "hereof," "hereunder" and "herein" shall refer to this Lease as a whole, except where noted otherwise.
- 11.12 **Survival of Obligations:** The provisions of this Lease with respect to any obligation of Tenant, including, without limitation, any indemnities of Tenant contained in this Lease, and Tenant's covenant to pay Rent, shall specifically survive the expiration or earlier termination of this Lease.
- 11.13 **Landlord and Tenant Relationship:** Nothing herein contained shall be deemed or construed by the parties hereto, nor by any other party, as creating the relationship of principal and agent or of partnership or of joint venture between the parties hereto. No estate shall pass from Landlord to Tenant, and this Lease shall not be subject to levy or sale.
- 11.14 **Counterclaim and Jury Trial:** In the event that the Landlord commences any summary proceedings or action for nonpayment of Rent or other charges provided for in this Lease, Tenant shall not interpose any counterclaim of any nature or description in any such proceeding or action. Tenant and Landlord both waive a trial by jury of any or all issues arising in any action

11.16 Representations: Tenant acknowledges that neither Landlord nor Landlord's agents, employees, or contractors have made any representations or promises with respect to the Premises, the Shopping Center, or this Lease, except as expressly set forth herein.

11.17 Landlord's Liability: In the event of any alleged default of Landlord, Tenant shall not seek to secure any claim for damages or indemnification by any attachment, levy, judgment, garnishment or other security proceedings against any property of the Landlord other than Landlord's equity in the Shopping Center. Landlord as used herein, shall include any assignee or other successor of the original Landlord or its successors or assigns.

11.18 Jurisdiction: The laws of the State in which the Shopping Center is located shall govern the interpretation, validity, performance, and enforcement, of this Lease.

11.19 Compliance with Law and Contracts. Tenant shall, at its expense, comply with and shall cause the Premises and Tenant's employees to comply with all Applicable Laws at all times during the Lease Term. Without limiting the foregoing, Tenant covenants and agrees to (a) conduct its operations on the Premises in a way that does not violate the Applicable Laws, and (b) take promptly, at its expense, whatever corrective measures are required by the Applicable Laws in the event of a violation. Tenant shall also, at its expense, comply with the requirements of all policies of insurance which at any time may be in force with respect to the Premises, and with the provisions of all contracts, agreements and restrictions affecting the Premises or any part thereof or the occupancy or use thereof. In addition, Tenant shall pay, as Rent, any future sales or rent tax or other tax imposed on Rent payments or upon Landlord based upon charges paid by Tenant to Landlord. "Applicable Laws" shall mean all laws, rules, orders, ordinances and regulations of the municipality, county and state in which the Premises are located, of the federal government, of any department or bureau of any of them, and of any other governmental authority having jurisdiction over the Premises, in effect from time to time during the Lease Term, which shall impose any duty on Landlord or Tenant with respect to the use, occupancy or alteration of the Premises, or Tenant's business conducted therein, including Environmental Laws and the Americans with Disabilities Act. Landlord makes no representation to Tenant that the conduct of the Permitted Use is permissible under Applicable Laws or under any private restrictions which are of public record, and Tenant agrees and acknowledges that it is Tenant's obligation to independently confirm same.

11.20 Authority and Good Standing. In the event Tenant hereunder is a corporation, limited liability company, partnership, or any other form of entity other than a natural person, the person(s) executing this Lease on behalf of Tenant hereby covenant and warrant that Tenant has been properly formed, is in good standing and is qualified to do business in the state in which the Shopping Center is located; all forms, reports, fees, taxes, and other documents and charges required to establish and maintain Tenant's good standing, qualification to do business and compliance with applicable laws have been and will continue to be filed and paid by Tenant when due; and such person(s) executing this Lease on behalf of Tenant are duly authorized by the appropriate persons or governing body of Tenant to execute and deliver this Lease on behalf of Tenant.

11.21 Estoppel Certificates: Within Seven (7) days after written request by Landlord, Tenant shall execute, acknowledge, and deliver, to Landlord, and to such other party or parties as may be designated by Landlord, a certificate stating that this Lease is in full force and effect and has not been modified, supplemented or amended in any way, except as indicated in such certificate; that all conditions and agreements hereunder to be performed by Landlord have been satisfied or performed, except as set forth in said certificate; that Tenant is not in default in the payment of Rent or any of the other obligations required of Tenant hereunder; that Tenant has paid Rent as of the date set forth in the certificate; and as to any other factual matter in connection with this Lease as is typically included in such statement of estoppel.

11.22 Entire Agreement: This Lease constitutes the entire agreement between the parties hereto with respect to the subject matter hereof and no subsequent amendment or agreement shall be binding upon either party unless it is signed by each party. The submission of this Lease shall not constitute an offer to Lease by Landlord and this Lease shall not be binding unless and until it is signed by Landlord and Tenant.

11.23 Exhibits and Addenda: All exhibits and addenda attached to this Lease are by this reference incorporated into this Lease. Insofar as such exhibits or addenda conflict with any of the terms or provisions contained in the text of this Lease, the terms and provisions of such exhibit or addenda shall govern and control.

11.24 Monthly and Annual Sales Reports. Intentionally Deleted.

11.26 Lease Valid and Binding. Notwithstanding that the Rent Commencement Date shall occur and the Lease Term shall commence after the date of execution of this Lease, upon complete execution by the parties hereto this Lease shall be and is in full force and effect and valid and binding against the parties in accordance with (but always on and subject to) its terms and conditions, except that this Lease shall terminate if for any reason the Rent Commencement Date shall not have occurred prior to the second anniversary of the date hereof.

11.27 No Representations. Nothing contained in this Lease or any exhibit or rider attached hereto shall be construed, deemed or interpreted to be a warranty, representation or agreement on the part of Landlord that any local, regional or national chain store or any other merchant shall open or remain open for or operate a business, or occupy or continue to occupy any premises in or about the Shopping Center parcel during the Lease Term or any renewal or extensions thereof.

11.28 Errors and Omissions. In the event that any inadvertent or unintentional clerical error(s) are made with respect to this Lease including (without limitation) square footage, operating expense estimates and other clear mathematical error(s) with respect to Minimum Rent or Additional Rent due hereunder whether said errors are in Landlord's or Tenant's favor, then both parties hereto agree to cooperate fully in order to correct said error(s) via an amendment to this Lease as required. This provision shall also apply to exclusive use violations, which may inadvertently be included in this Lease.

deemed an accord and satisfaction, and Landlord may accept such check or payment without prejudice to Landlord's right to recover the balance of such rent or pursue any other remedy provided in this Lease.

11.31 Counterparts. This Lease may be executed in one or more counterparts, each of which shall be deemed an original, but all of which together shall constitute one agreement.

11.32 EXHIBITS:

- A. Site Plan
- A-1 Legal Description of the Shopping Center
- B. Landlord's Work
- C. Prohibited Uses
- D. Sign Criteria
- E. Form of Guaranty
- F. Rules and Regulations
- G. Kitchen's work & Out Door Dining Built Out

11.33 Firearms. Tenant shall at all times prominently display signage prohibiting the carrying of firearms within the Premises to the extent same is permissible under applicable law and shall make its commercially reasonable efforts to prohibit the carrying of firearms and to enforce same.

11.34 No Easement for Light, Air, or View. Any elimination or shutting off of light, air, or view by any structure which may be erected on lands adjacent to the Premises shall in no way affect this Lease and Landlord shall have no liability to Tenant with respect thereto.

11.35 No Estate in Land. This contract and Lease shall create the relationship of landlord and tenant between Landlord and Tenant and no estate shall pass out of Landlord; Tenant has only a usufruct which is not subject to levy and sale, and not assignable by Tenant except as herein provided.

11.36 Confidentiality. Tenant hereby acknowledges and agrees with Landlord that the amount of Rent due and payable under this Lease and all other terms of this Lease negotiated between Landlord and Tenant shall be and remain confidential to the parties to this Lease, and Tenant, in consideration of Landlord's entering into this Lease, hereby agrees with Landlord that Tenant shall not disclose in any manner to any third party, except as may be required by law, the amount of the Rent due and payable by Tenant under this Lease or any of the other terms of this Lease; provided, however, that Landlord may disclose the terms of this Lease to potential lenders of Landlord, mortgagees or other parties taking a secured interest in the Premises, any investors, partners, or joint venture participants holding or potentially holding an interest in the Premises, and said parties' accountants, attorneys, and other representatives, and to any other third party with a reasonable need to know the terms of this Lease.

11.37 Landlord Lien. Landlord shall at all times have a valid first lien upon all of the personal property of Tenant situated in the Premises to secure payment of rent and other sums and charges due hereunder from Tenant to Landlord and to secure the performance by Tenant of each of the covenants, warranties, agreements and conditions hereof. Said personal property shall not be removed from the Premises without the consent of Landlord until all arrearage in Rent and other charges, as well as any and all other sums of money due hereunder shall first have been paid and discharged and until this Lease and all of the covenants, conditions, agreements and provisions have been fully performed by Tenant. Tenant shall from time to time execute any financing statements and other instruments necessary to perfect the security interest granted herein, and Landlord shall have the right to file any such financing statements as is necessary to perfect Landlord's security interest herein contained. The lien herein granted may be foreclosed in the manner and form provided by law for the foreclosure of security instruments or chattel mortgages, or in any other manner provided by law. This Lease is intended as and constitutes a security agreement within the meaning of the Uniform Commercial Code, as same is enacted by Governing Law.

11.38 WAIVER OF JURY TRIAL. TO THE EXTENT PERMITTED BY LAW, LANDLORD AND TENANT SHALL, AND THEY DO HEREBY, WAIVE TRIAL BY JURY IN ANY ACTION, PROCEEDING OR COUNTERCLAIM BROUGHT BETWEEN THE PARTIES HERETO OR THEIR SUCCESSORS OR ASSIGNS ON ANY MATTERS ARISING OUT OF, OR IN ANY WAY CONNECTED WITH, THIS LEASE, THE RELATIONSHIP OF LANDLORD AND TENANT, AND/OR TENANT'S USE OF, OR OCCUPANCY OF, THE PREMISES. TENANT SHALL NOT INTERPOSE ANY COUNTERCLAIM OR COUNTERCLAIMS IN A SUMMARY PROCEEDING OR IN ANY ACTION BASED UPON NON-PAYMENT OF RENT OR ANY OTHER PAYMENT REQUIRED BY TENANT HEREUNDER. THIS WAIVER IS MADE FREELY AND VOLUNTARILY, WITHOUT DURESS AND ONLY AFTER EACH OF THE PARTIES HERETO HAS HAD THE BENEFIT OF ADVICE FROM LEGAL COUNSEL ON THIS SUBJECT.

11.39 Lockbox. Landlord may, at its sole option, direct Tenant to pay Rent to a "lockbox" or other depository whereby checks issued in payment of Rent are initially cashed or deposited by a person or entity other than Landlord (albeit on Landlord's authority), then, in such event, for any and all purposes under this Lease: (i) Landlord shall not be deemed to have accepted such payment until ten (10) days after the date on which Landlord shall have actually received such funds, and (ii) Landlord shall be deemed to have accepted such payment if (and only if) within said ten (10) day period, Landlord shall not have refunded (or attempted to refund) any payment not made in strict compliance with this Lease to Tenant. Nothing contained in the immediately preceding sentence shall be construed to place Tenant in default of Tenant's obligation to pay Rent if and for so long as Tenant shall timely pay the entire Rent required pursuant to this Lease in the manner designated by Landlord. Further, upon Tenant's receipt of written notice from Landlord's mortgagee directing Tenant to deliver Rent and other sums due hereunder directly to mortgagee (or to an agent designated by such mortgagee), Tenant shall comply accordingly and is authorized by Landlord to do so.

11.41. Standard of Discretion. In any event Landlord's consent is required hereunder, unless expressly set forth to the contrary

IN WITNESS WHEREOF, the parties hereto have executed this Lease under seal the day and year first above written. This Agreement may be signed electronically and in multiple counterparts which when assembled shall constitute an original.

LANDLORD: Lithonia Property, LLC., a Georgia Limited Liability Corporation

Name: Taib Elkettani
Its: Taib Elkette
Date: 12/6, 2018

TENANT: United Entertainment LLC., a Georgia Limited Liability Corporation

Name: Bernice P. Monger
Its: ~~Bernice P. Monger~~
Date: 12/6, 2018

Special Land Use Permit Criteria

Analyze the impact of the proposed rezoning and provide a written point-by-point response to the following questions:

a. Adequacy of the size of the site for the use contemplated and whether or not adequate land area is available for the proposed use including provision of all required yards, open space, off-street parking, and all other applicable requirements of the zoning district in which the use is proposed to be located;

- There is no change being made to the building and business operation. However, there is adequate space as we are currently open on Friday and Saturday after midnight with sufficient parking provided for customers.

b. Compatibility of the proposed use with adjacent properties and land uses and with other properties and land uses in the district;

- Barnacles Sport Lounge has been open for over 2 years and is comparable with surrounding properties and land uses in the district.

c. Adequacy of public services, public facilities, and utilities to serve the use contemplated;

- There is no change being made to the building and business operation. Obtaining the permit will not affect current public services, facilities, and utilities.

d. Adequacy of the public street on which the use is proposed to be located and whether or not there is sufficient

traffic-carrying capacity for the use proposed so as not to unduly increase traffic and create congestion in the area;

- There is no change being made to the building and business operation. There is sufficient public street and this permit will not increase traffic nor create congestion.

e. Whether or not existing land uses located along access routes to the site will be adversely affected by the character of the vehicles or the volume of traffic generated by the proposed use;

- Access route will not be adversely affected by the character of the vehicles or the volume of traffic.

f. Ingress and egress to the subject property and to all proposed buildings, structures, and uses thereon, with particular reference to pedestrian and automotive safety and convenience, traffic flow and control, and access in the event of fire or other emergency;

- There is no change being made to the building that will affect pedestrian and automotive safety. The previous approval of entrances and exit route approved by city of Stonecrest planning and zoning remains remain intact with no changes made.

g. Whether or not the proposed use will create adverse impacts upon any adjoining land use by reason of noise, smoke, odor, dust, or vibration generated by the proposed use;

- The permit will not create any additional adverse impact to adjoined land use from noise, smoke, odor, dust, or vibration as there is no changes being made to the building or the business operation.

h. Whether or not the proposed use will create adverse impacts upon any adjoining land use by reason of the hours of operation of the proposed use;

- The permit will not create any additional adverse impact by hours of operation.

i. Whether or not the proposed use will create adverse impacts upon any adjoining land use by reason of the manner of operation of the proposed use;

- The permit will not create any additional adverse impact to adjoined land use from manner of operation.

j. Whether or not the proposed plan is otherwise consistent with the requirements of the zoning district classification in which the use is proposed to be located;

- There is no change being made previously approved site plan, which is consistent with the requirements of the zoning district classification as approved by planning and zoning.

k. Whether or not the proposed use is consistent with the policies of the comprehensive plan;

- The permit is consistent with policies

l. Whether or not the proposed plan provides for all required buffer zones and transitional buffer zones where required by the regulations of the district in which the use is proposed to be located;

- Plan does not

m. Whether or not there is adequate provision of refuse and service areas;

- There is adequate vision of refuse and service area

n. Whether the length of time for which the special land use permit is granted should be limited in duration;

- The permit should not be limited in duration due to the fact that the business is located and zoned in the area that is already approved for late night entertainment.

o. Whether or not the size, scale and massing of proposed buildings are appropriate in relation to the size of the

subject property and in relation to the size, scale and massing of adjacent and nearby lots and buildings;

- The size, scale, and massing are appropriate, there is no change being made to building.

p. Whether the proposed plan will adversely affect historic buildings, sites, districts, or archaeological resources;

- The plan will not adversely affect any historic buildings, sites, districts, or archaeological resources.

q. Whether the proposed use satisfies the requirements contained within the supplemental regulations for such special land use permit;

- The special land use permit to open after midnight satisfies the requirements of Zone C1.

r. Whether or not the proposed building as a result of its proposed height will create a negative shadow impact on any adjoining lot or building;

- There is going to be no physical change to the building therefore creating no negative shadow impact on any adjoining lot or building.

s. Whether the proposed use would result in a disproportionate proliferation of that or similar uses in the subject character area; and

- Remain open after midnight will not result in an disproportionate proliferation

t. Whether the proposed use would be consistent with the needs of the neighborhood or to the community as a

whole, be compatible with the neighborhood,

- Remaining open after midnight will not provide any changes to the community or neighborhood as Barnacles Sport Lounge is currently located in zone C1 which is apart of the zoning that allow and is approved for late night entertainment per planning and zoning department.